

**YAMAHA**

**CS70M**

DUAL CHANNEL POLYPHONIC SYNTHESIZER  
OWNER'S MANUAL

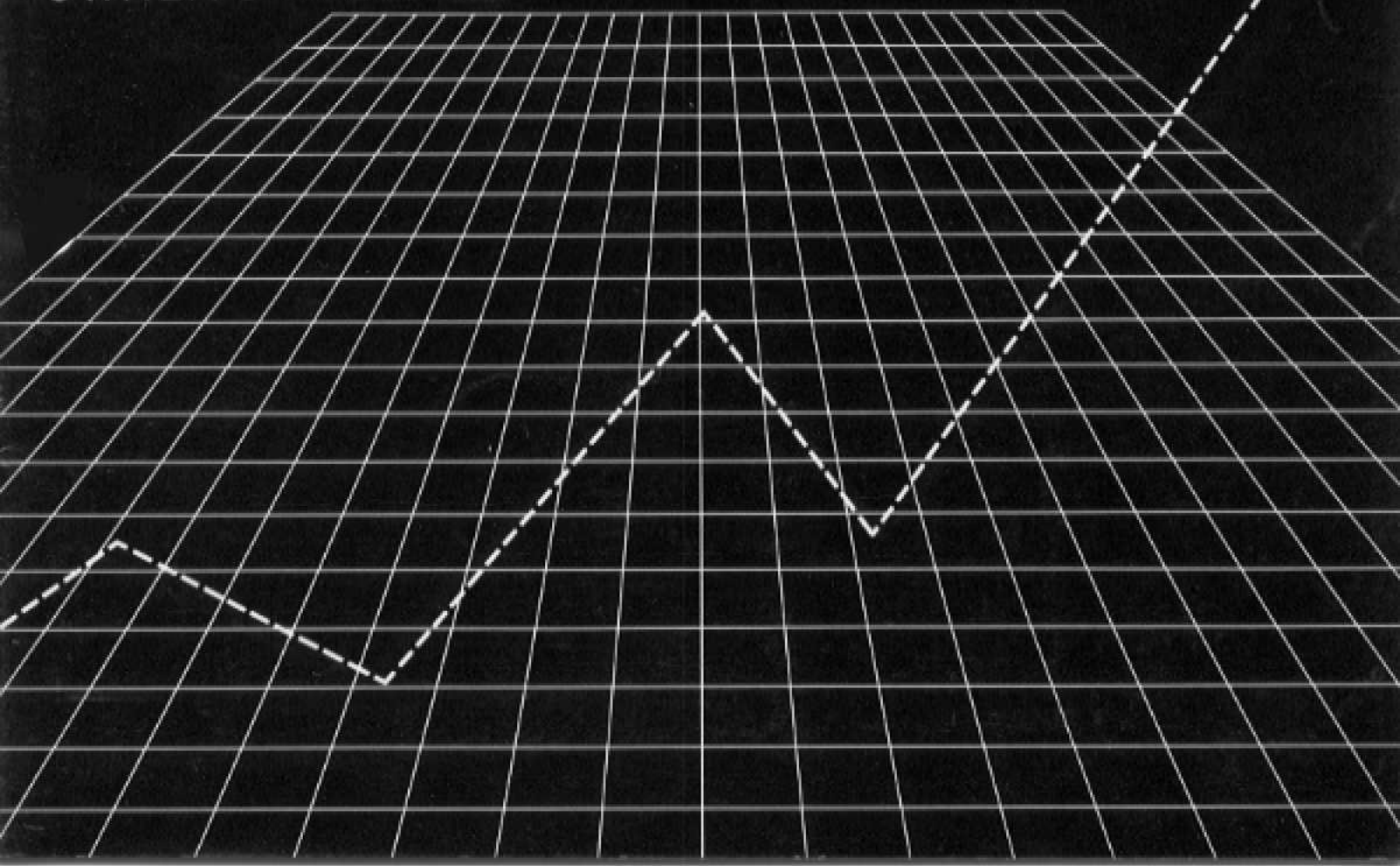

**WARNING :** TO REDUCE THE RISK OF FIRE OR ELECTRIC SHOCK, DO NOT EXPOSE THIS APPLIANCE TO RAIN OR MOISTURE. THERE ARE NO USER-SERVICEABLE PARTS INSIDE. REFER SERVICING TO A QUALIFIED SERVICE PERSONNEL.

#### **SERVICE**

The CS70M is supported by Yamaha's worldwide network of qualified dealer service personnel. In the event of a problem, contact your nearest Yamaha dealer or authorized service center.

Thank you for buying the Yamaha CS70M programmable dual channel polyphonic synthesizer. To ensure that you get maximum performance from this sophisticated instrument, be sure to read this operating manual before use, and keep it in a safe place for later reference.

## Table of Contents

<i>Introduction</i> . . . . .	3
<i>Setup</i> . . . . .	5
<i>Connections</i>	
<i>Amplifier/Speaker</i> . . . . .	6
<i>Optional Tools</i> . . . . .	7
<i>Operations</i>	
<i>Basic Control Setting</i> . . . . .	8
<i>Keyboard</i> . . . . .	9
<i>Tuning</i> . . . . .	10
<i>Mode</i> . . . . .	11
<i>VCO</i> . . . . .	13
<i>VCF</i> . . . . .	15
<i>VCA</i> . . . . .	17
<i>LFO</i> . . . . .	18
<i>Programming</i> . . . . .	21
<i>Write/Call/Edit</i> . . . . .	22
<i>Edit</i> . . . . .	23
<i>Store</i> . . . . .	24
<i>Load/Sequencer</i> . . . . .	25
<i>Sequencer</i> . . . . .	26
<i>Effects</i> . . . . .	29
<i>LFO</i> . . . . .	30
<i>After Touch/Chorus</i> . . . . .	31
<i>Sound Patch Chart</i> . . . . .	32
<i>Summary of Operations</i> . . . . .	33
<i>Trouble Shooting</i> . . . . .	35
<i>Block Diagram</i> . . . . .	37
<i>Specifications</i> . . . . .	38

# Introduction

The Yamaha CS70M programmable dual channel polyphonic synthesizer offers full six-voice polyphonic capability, an internal memory system capable of storing up to 30 sounds, a built-in magnetic card reader/writer that provides unlimited external sound storage capacity, and a sophisticated built-in polyphonic sequencer. In addition to these extraordinary features the CS70M has a full complement of sound parameter controls, many of which are remarkably innovative, and an extensive range of effects. Just a few moments at the CS70M's keyboard will convince you of the enormous expressive potential it offers – expressive potential and creative freedom so vast that your musical scope will never be limited.

Conventional non-programmable synthesizers are fine for studio work, but they tend to limit your flexibility on stage due to the time required for repatching whenever a new sound is needed. The CS70M lets you pre-program up to 30 separate voices, each comprising 39 voice parameters, for instant recall during performance at the touch of a button. It also incorporates a magnetic data card system that provides literally unlimited storage capacity. Sounds you create with the voice parameter controls can be digitally stored on external memory cards, and then later reloaded into the internal memory.

The built-in 4-bank polyphonic sequencer can be valuable as an extra pair of hands in live performance situations. It can record up to 4 independent note sequences exactly as played with six-note polyphonic capability.

The CS70M has an extremely sophisticated split keyboard system. It features a programmable split point, the capability of playing different pairs of voices on the two sides of the split, and a split balance control.

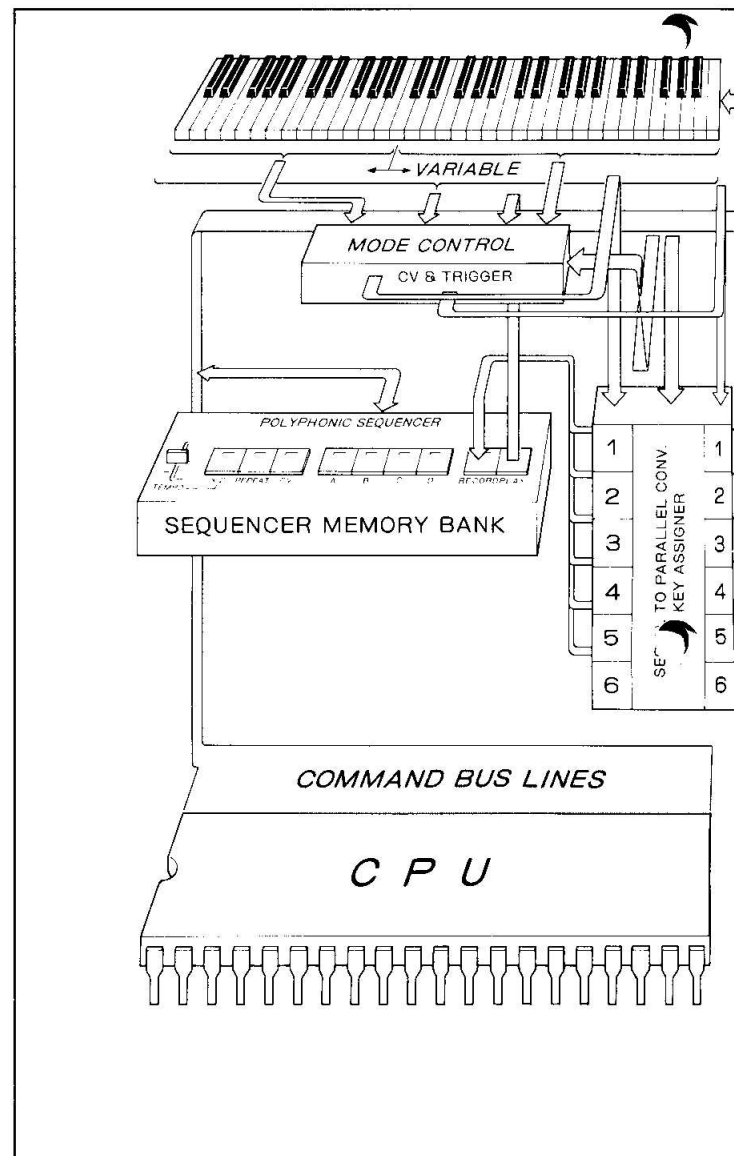



In addition to its highly versatile low frequency oscillator section, the CS70M also offers an independent LFO that provides a broad range of manual LFO modulation possibilities. The independent LFO can be used to modulate the VCOs, VCFs, and VCAs – independently or in combination – via the modulation wheel, an optional foot pedal, or the exclusive built-in keyboard after-touch sensitivity.

With the CS70M's infinite possibilities for sound creation, plus extensive expression control, it's sure to open up a whole new world of creative freedom.

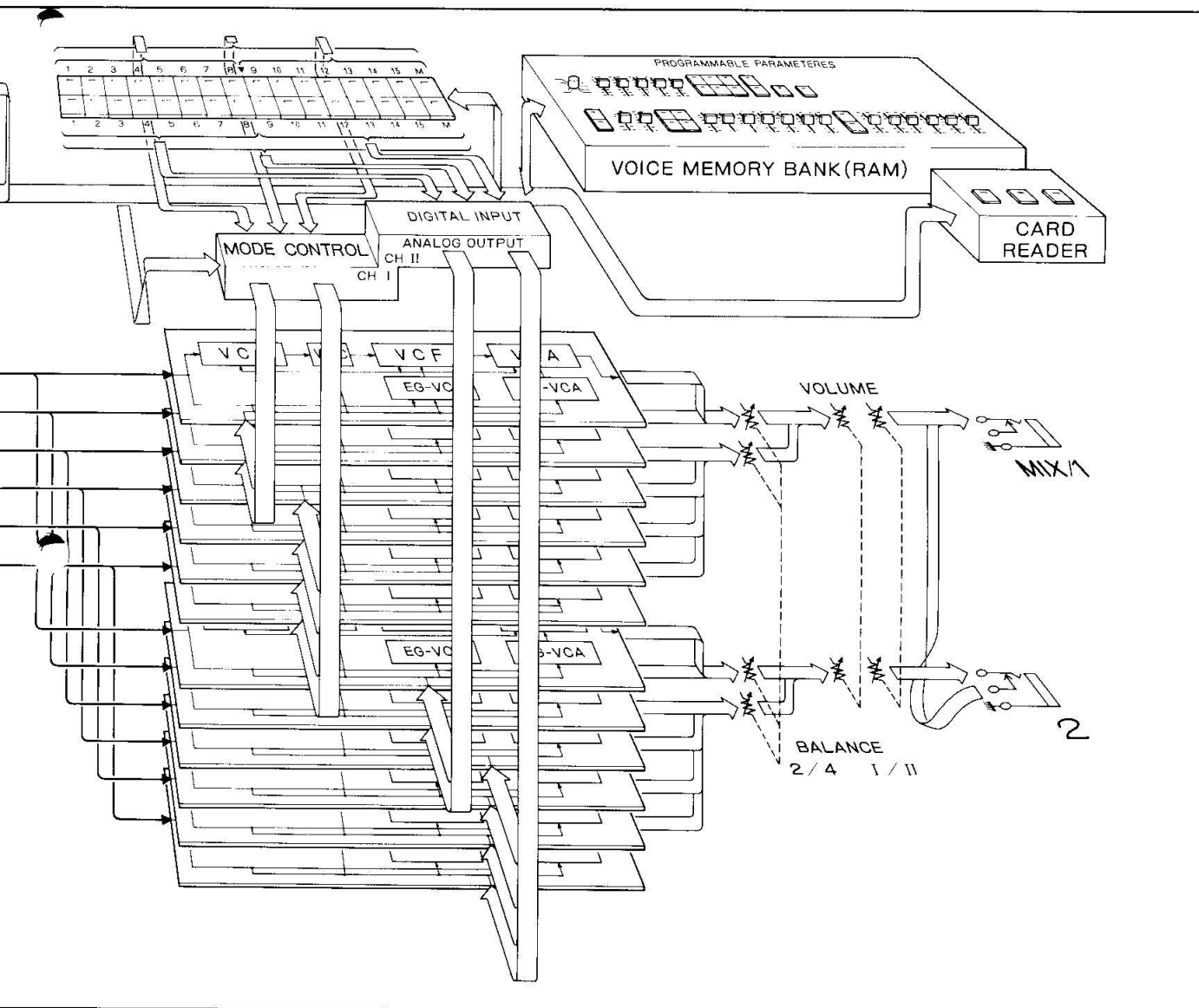

# Setup

## Loading the Back-up Batteries

The CS70M employs batteries to preserve the contents of the RAM memory so that programmed voices can be retained even when power is switched off. Load the batteries prior to connection and operation.

1. Disconnect the power cord to prevent possible short-circuits when loading the batteries.
2. As shown in the illustration, load the 3 alkali 1.5 volt batteries supplied with the unit.
3. The life of the batteries is about 2 years. Use alkali batteries for replacement. Replace all 3 batteries at the same time.
4. Timely replacement of batteries will prevent trouble with leakage of old batteries.

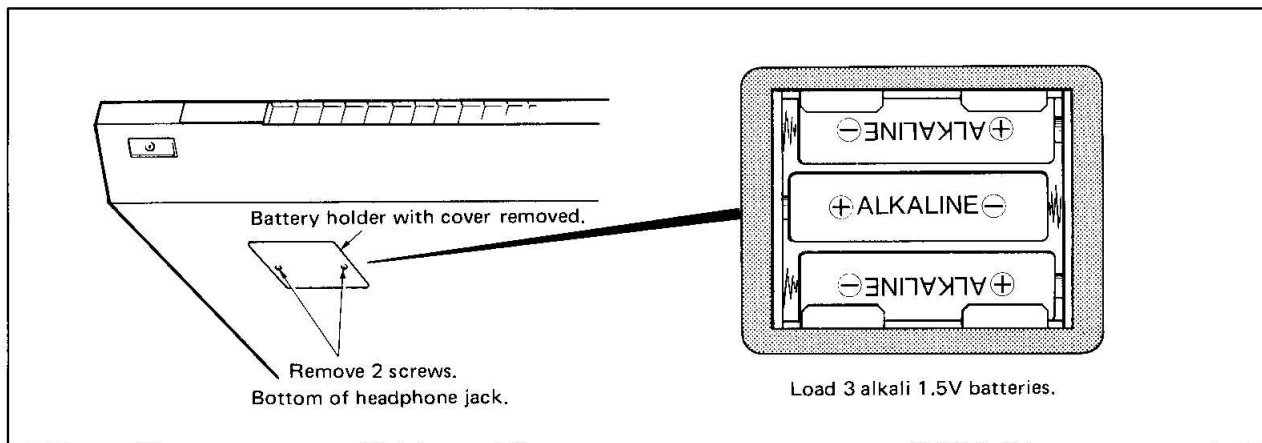

## ① VOLTAGE SELECTOR

Before applying power, check that the voltage selector is set for the line voltage in your area. If it is incorrect, remove the two switchguard screws, set the switch to the correct voltage setting, and replace the switchguard. Operating the CS70M at the wrong voltage setting will result in impaired performance or even severe damage to the unit. After the voltage selector has been verified, plug line cord into an AC outlet.

## ② POWER SWITCH

## ③ POWER CORD CONNECTOR

Plug in the line cord here.

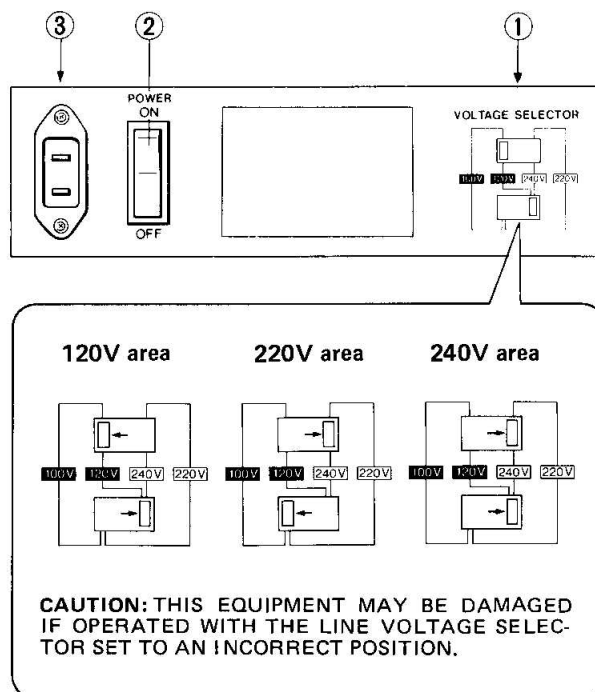

The CS70M does not incorporate a power amplifier. Therefore, it is necessary to connect it to an amplifier/speaker system except when headphones are being used.

## OUTPUT BLOCK

- The output level is compatible with conventional line level inputs including keyboard amplifiers or mixers.
- Be sure to observe the maximum input ratings of amplifiers speakers are used. A signal exceeding the rated capacity may burn out the voice coil of the speaker.

### Nominal output level

Mixed Balanced	.....	-20 dBm
Mixed/1, 2	.....	-14 dBm

### ④ MIXED BALANCED

This is a balanced XLR connector for mixed output from channels I and II. Use this connector for output to a professional type mixer with low impedance (balanced or unbalanced) inputs.

### ⑤, ⑥ MIXED/1, 2

These are unbalanced output jacks for standard 1/4" phone plugs, and can provide either mixed output or separate channel I and II outputs.

When a plug is inserted only into the MIXED/1 jack ⑤, the mixed output of both channels is available. When plugs are inserted both jacks mixed 1, and 2, separate signals from channels I and II are present.

### ⑦ PHONES (front, lower left)

Use with all stereo headphones. This jack carries the signals from channels I and II mixed – the same as the MIXED jack.

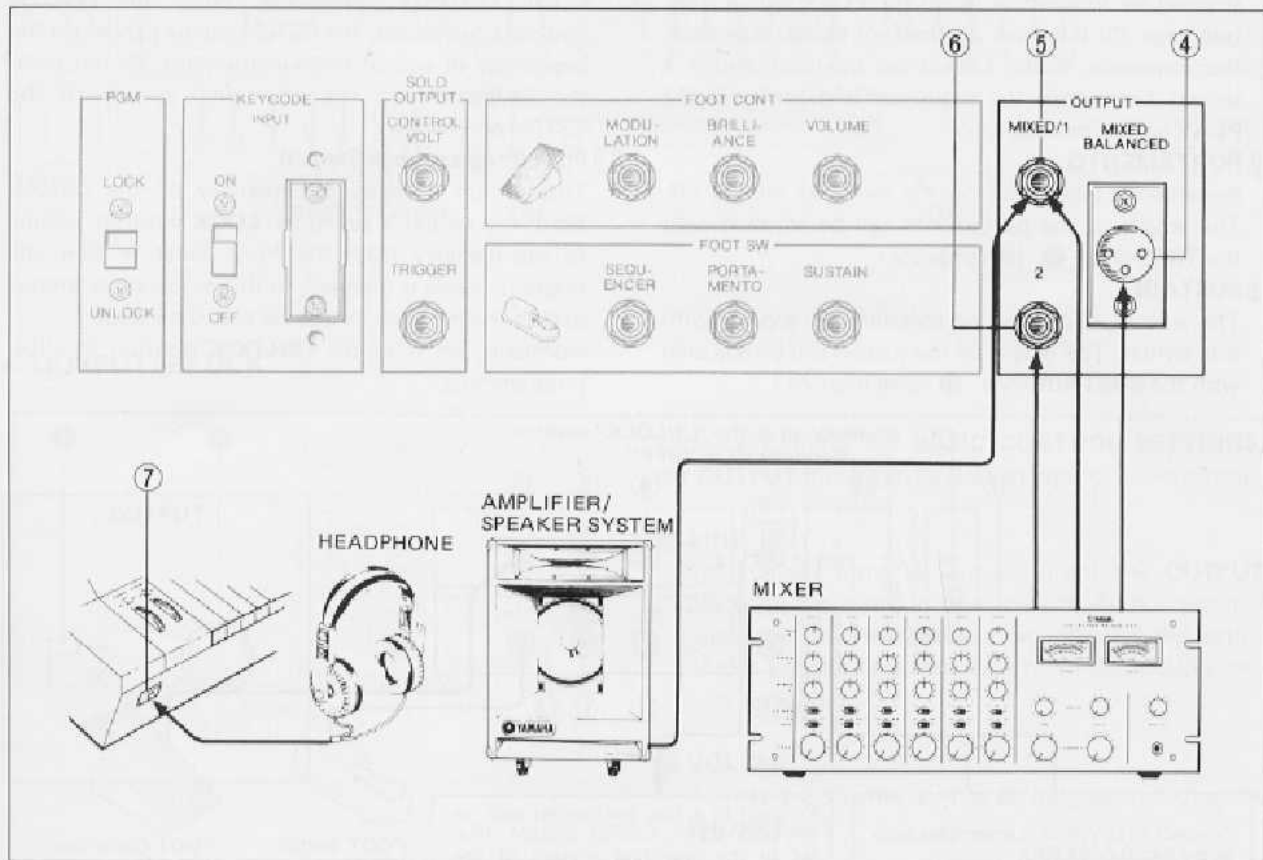

The CS70M has several connections for optional equipment. There are jacks for foot switches, foot controllers, and a data input/output terminal for connection to other Yamaha synthesizers.

## FOOT CONT

These 3 jacks are for use with optional **FC-3A** foot controllers.

### ⑧ MODULATION

The LFO modulation effect can be controlled with a foot controller. When the foot controller is plugged into this jack, the MODULATION wheel on the left side of the keyboard is disabled. (See page 30.)

### ⑨ BRILLIANCE

Brilliance can also be controlled with the **FC-3A** foot controller.

### ⑩ VOLUME

Overall output volume can be adjusted.

## FOOT SW

These 3 jacks are for use with optional **FC-4** foot switches, for the control of sustain, portamento, and the built-in polyphonic sequencer.

### ⑪ SEQUENCER

Sequencer playback can be automatically started and stopped by footswitch. When the **PLAY** switch (see page 25) is turned on the foot switch is pressed, the sequencer starts. Depressing the foot switch a second time stops the sequencer and turns off the **PLAY** switch indicator.

### ⑫ PORTAMENTO

Portamento (glissando) can be switched on and off. The length of the portamento can be adjusted with the **TIME** lever (see page 29.)

### ⑬ SUSTAIN

The sustain effect can be switched on and off with this switch. The length of the sustain can be adjusted with the **SUSTAIN** lever (See page 29.)

## SOLO OUTPUT

SOLO OUTPUT has two output phone jacks which provide a control voltage (CV) indicating the pitch of the highest note presently being played, and a trigger voltage (Trigger) which indicates keyboard on/off. These allow the CS70M to be connected to any **YAMAHA solo synthesizer**, which will then automatically follow the highest notes played on the CS70M.

### ⑭ CONTROL VOLT

This jack provides a 1 Hz/V control voltage signal, and should be connected to the **CONTROL VOLTAGE IN** jack of the solo synthesizer.

### ⑮ TRIGGER

This jack carries a negative-going trigger voltage, and should be connected to the **TRIGGER IN** terminal of the solo synthesizer.

### ⑯ KEY CODE INPUT

This connector inputs keycode data from the keyboards of **YAMAHA SK30** and **SK50D SYMPHONIC ENSEMBLES** and **CP35 PIANO**, which have **KEY-CODE OUTPUT** connectors. When the keycode switch is turned on, the CS70M can be played via the keyboards of any of these instruments. At this time, the keyboard and the aftertouch feature of the CS70M are inactive.

### ⑰ PGM (Program Lock Switch)

This switch protects the memory of the CS70M. When the switch is set to the **LOCK** position, writing to the memory from the front panel or from the magnetic cards is disabled. In this mode, programmed data in the memory cannot be erased by error. Normally, set it to the **UNLOCK** position to allow programming.

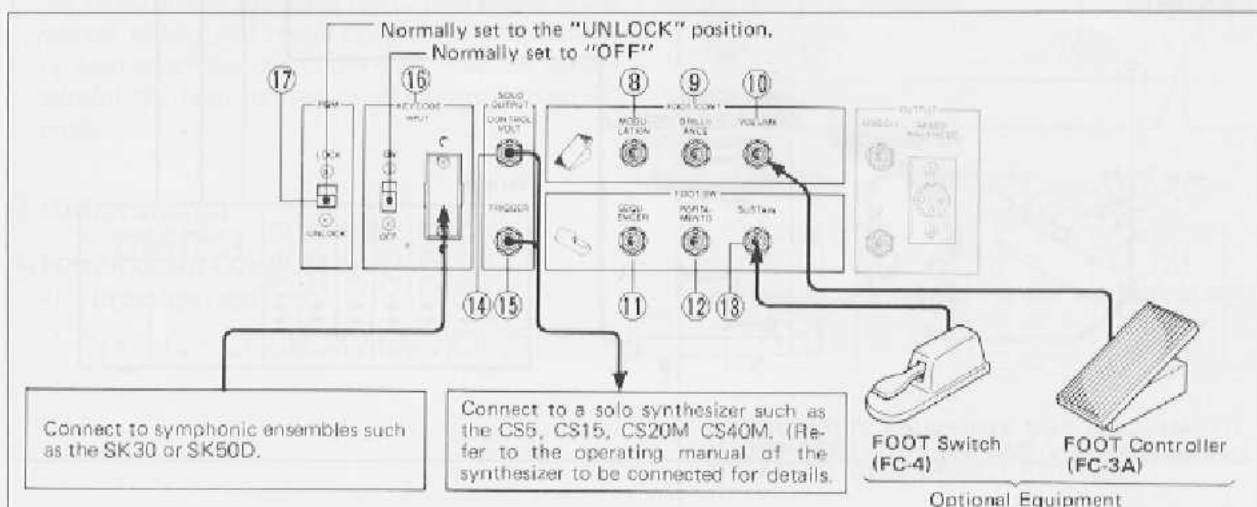

The operation of the synthesizer will be explained a section at a time on the following pages. Return the synthesizer controls to their nominal settings with the **BASIC CONTROL SETTINGS** in the examples listed below. With the **BASIC CONTROL SETTINGS** the various sound-producing waveforms and control functions of the synthesizer can be checked:

- Before using the synthesizer for the first time.
- For generating sounds to check the synthesizer, amplifier and other equipment.
- When the synthesizer status is unknown.

1. Turn on the **POWER** switch.
2. Turn on both of the grey **MANUAL** program select switches. The VCO (square wave) and the LFO (sine wave) should light up in the **PROGRAMMABLE PARAMETERS** block.
3. Turn off any indicators that are on except in the **PROGRAMMABLE PARAMETERS** block. (This happens automatically when power is first turned on.)
4. Set all other switches, levers, and knobs as shown below.

## Basic Control Settings

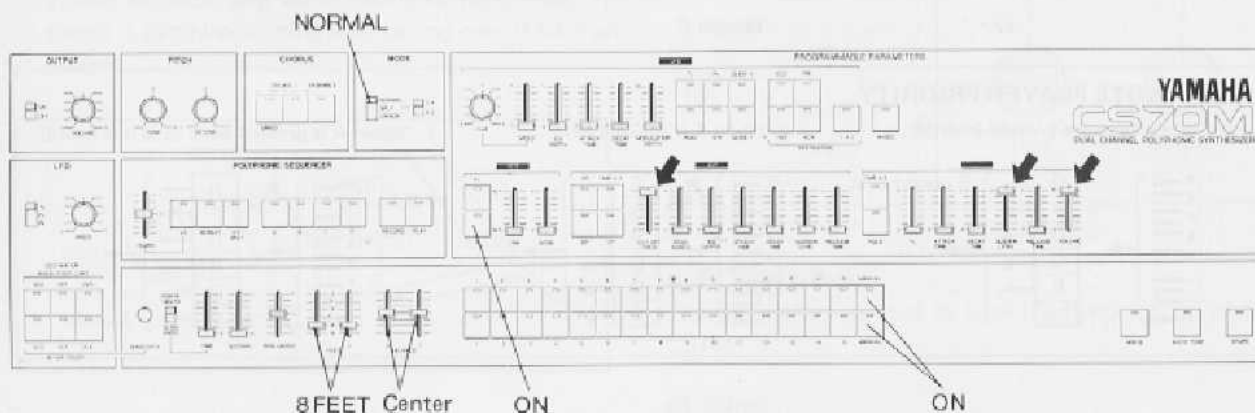

## ■ OUTPUT BLOCK

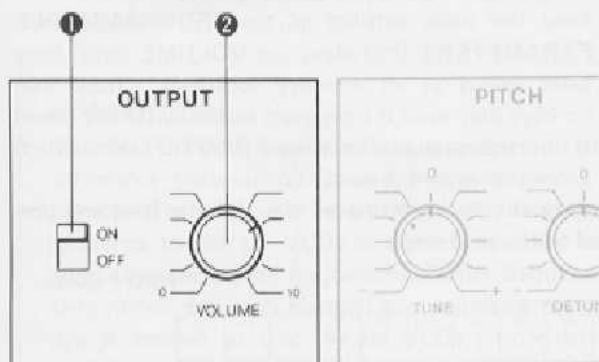

After performing the **BASIC CONTROL SETTINGS**, the **OUTPUT** block can be used to control audio output.

### 1 LINE OUT

This switch turns all outputs from the **OUTPUT** block on the rear panel on and off. Audio output is present at the **PHONES** jack regardless of the setting of the switch. Turn this switch off for headphones-only operation.

### 2 VOLUME

Adjusts the volume level at all outputs including the **PHONES** jack.

### 3 KEYBOARD

The CS70M has 61 keys covering 5 octaves. The range varies with the setting of the **FEET** switch 12. (see page 14). When the switch is set to 8 feet, the keyboard covers C1 through C6. Up to six keys can be

depressed at once, producing six tones. When still more keys are pressed, the note of the key first depressed ends. (Priority to the last key played). For further details, refer to page 11, **MODE**.

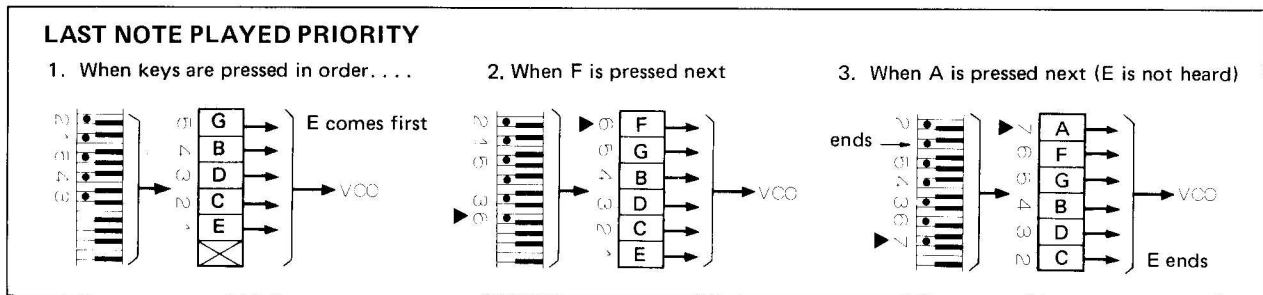
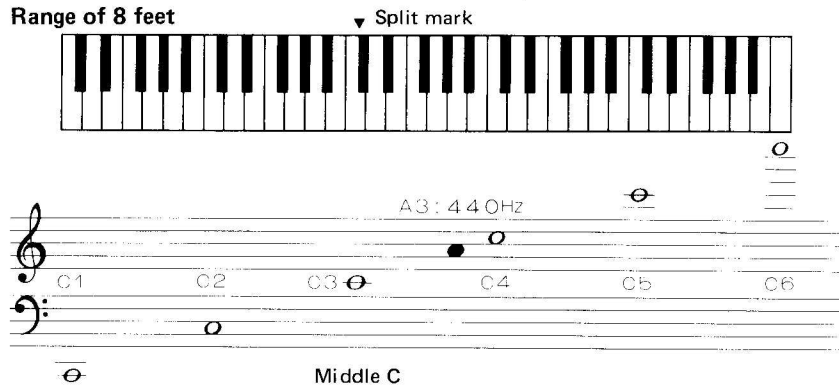

### ■ INITIAL MEMORY CLEAR

Initially, select the grey **MANUAL** switches to begin programming. No programs are in upper and lower memories 1 through 15. However, if any unprogrammed memory buttons are selected, random data may be present. This will cause extraneous signals at the outputs when any keys are depressed. Therefore, to initialize the programming process, perform the following memory clear operation.

1. Push down the **VOLUME** lever in the right-hand end of the programmable parameters. In this condition, no sound is produced even if a key is pressed.

2. While holding down the **WRITE** switch on the lower right side of the panel, press the program select switches (1 through 15) in sequence, first the upper row, and then the lower.
3. Now the basic settings of the **PROGRAMMABLE PARAMETERS** (including the **VOLUME** lever) have been stored in all memory locations. Check that no keys play even if a program select switch is pressed. If the indicator blinks when a program select switch is pressed, press the switch again.

**Restore the basic setting of the Volume level and proceed to the next step.**

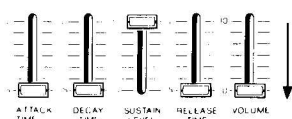

1. Slide down the **VOLUME** lever

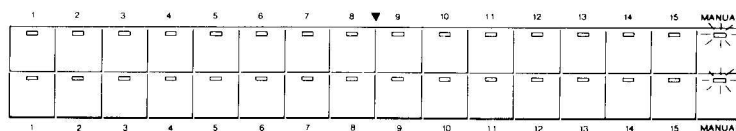

2. While pressing the **WRITE** switch, press the program select switches (1 through 15)

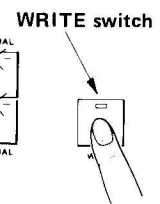

*These controls determine the basic real-time operation of the synthesizer and are not programmed in the memory.*

## ■ AUTO TUNE

The CS70M is a polyphonic synthesizer equipped with 12 VCO's (**VOLTAGE CONTROLLED OSCILLATOR**) for six tones each in two channels. It is important that the six sets of VCOs be tuned to the same pitch when a CV (control voltage) of the same value is applied to the respective VCOs of two channels. The **CS70M AUTO TUNE** function can perform this operation automatically. Be sure to perform the **AUTO TUNE** before tuning with the **TUNE** in the **PITCH** block.

### ④ AUTO TUNE

Depress and release the **AUTO TUNE** switch on the lower right of the panel. The indicator lights up for a few seconds, and auto tuning is performed. No sound is produced during auto tuning even if keys are pressed.

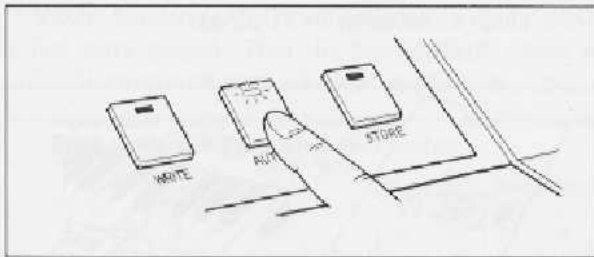

- **AUTO TUNE** is performed independently on channels I and II. Detune status is maintained even if **AUTO TUNE** is performed.
- About 15 minutes is required until the operation is stabilized after the power switch is turned on. Perform **AUTO TUNE** about 15 minutes after the power is switched on.

## ■ AUTO TUNE

The **AUTO TUNE** feature solves the problem of pitch difference between VCOs and improves tuning accuracy. The computer sends a standard voltage in sequence to the six VCOs in each channel and measures their oscillation frequencies. Center frequency is determined for each channel and supplemental voltage is applied so that the six VCOs all oscillate at that center frequency.

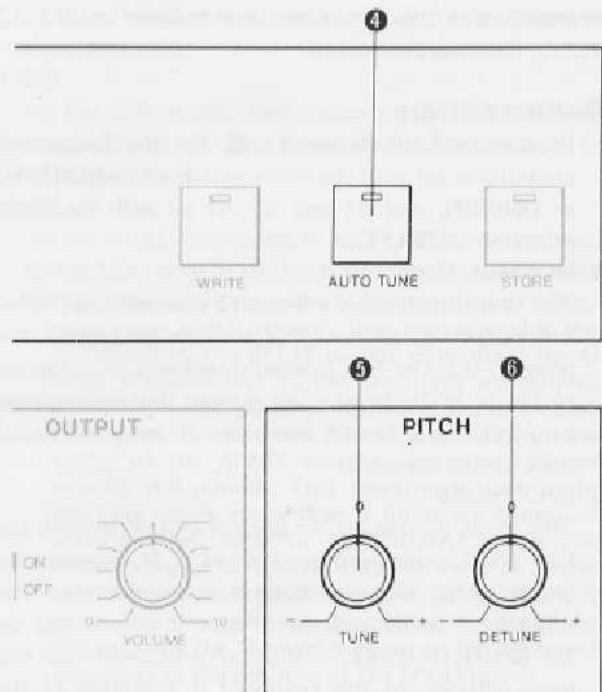

## ■ PITCH block

The pitch block is used to tune the overall pitch of the CS70M.

### ⑤ TUNE

The absolute pitch of channels I and II can be adjusted over a range of  $\pm 100$  cents.

### ⑥ DETUNE

The pitch of **CHANNEL II** can be offset from that of **CHANNEL I**. This is used for "detune" type effects.

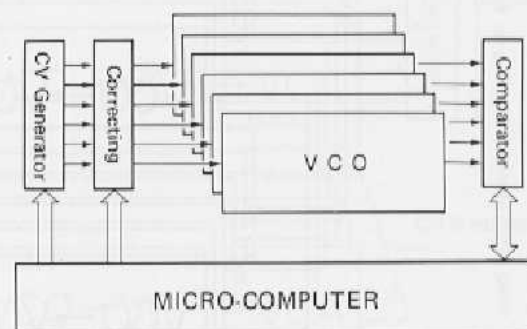



## MODE block

The **MODE** block determines how the key data (of the keyboard and the sequencer) are assigned to the 12 VCO's, (6 notes/2 channels).

## 7 MODE SWITCH

Program select switches #1 (12) for the 2 channels are initially set with the mode switch set in **NORMAL** or **UNISON**, and #1 and #9 are set with the mode switch set at **SPLIT**.

### ◆ NORMAL Mode

The unit functions as a **6-note, 2-channel** polyphonic synthesizer. When more than six keys are pressed, the note of the key first pressed disappears and changes to the note of the key last pressed (last-note-played priority). Also, up to six notes at once be played back by the sequencer.

### □ SPLIT mode

This mode divides the six pairs of VCO's between the high and low range of the keyboard, or, between the whole range of the keyboard and sequencer. The number of notes assigned to each is determined by the **SPLIT** switch (8). A split point between low and high portions of the keyboard is cancelled at the moment when the **PLAY** switch of the sequencer is pressed. A split between the sequencer and the whole range of the keyboard is then activated.

- The **PLAY** mode of the sequencer is switched off upon completion of sequencer playback. Then, the split goes back to being between the low and high ranges of the keyboard.

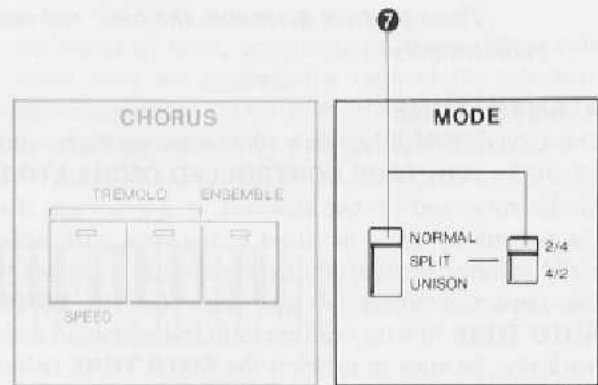

## PROGRAMMING THE SPLIT POINT

To program the split point on the keyboard, depress and hold the key of the position where the split is desired, while changing the **MODE** switch from **NORMAL** to **SPLIT** or from **UNISON** to **SPLIT**. Unless otherwise specified, after turning power on, the split is at the position marked (▼), which divides the keyboard into a low sound range of 2 octaves and a high sound range of 3 octaves.

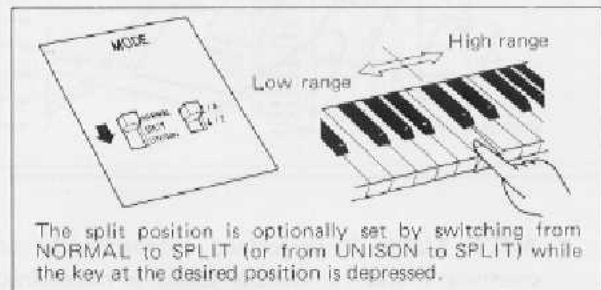

The split position is optionally set by switching from **NORMAL** to **SPLIT** (or from **UNISON** to **SPLIT**) while the key at the desired position is depressed.

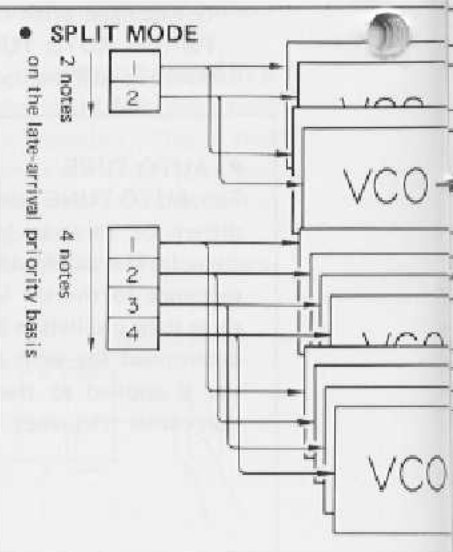
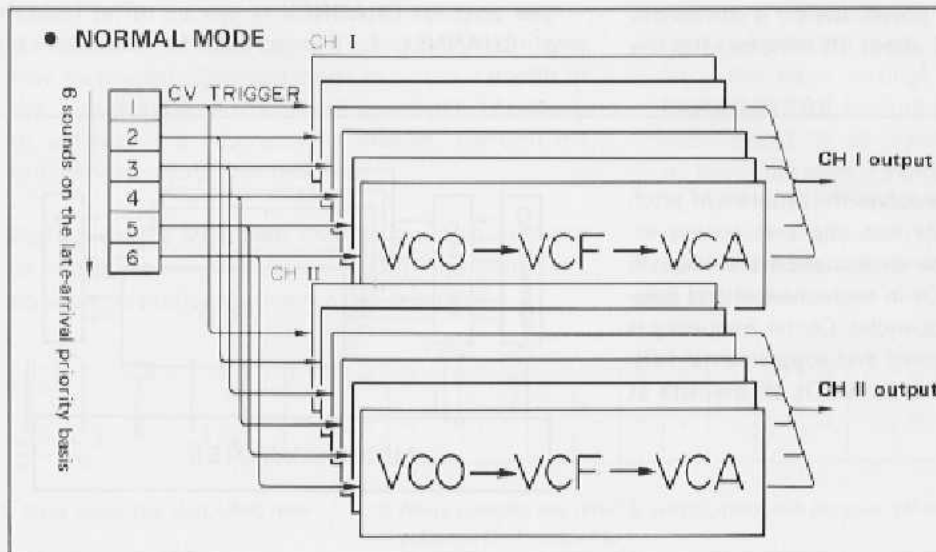



- When changing the **MODE** switch to **SPLIT**, be careful not to accidentally press any keys, as the split position will change.

## SPLIT OF VOICES

In the **SPLIT** mode, program select switches 1 through 8 are assigned to the low range of the keyboard (or the sequencer, if it is in the "play" mode), and switches 9 through 15 to the high range of the keyboard, or to the whole range of the keyboard when the sequencer play is used.

### UNISON mode

When the **MODE** switch is set to **UNISON** all six VCOs in each of the two channels are triggered irrespective of the number of keys depressed. When only a single note is pressed, the same key "played" data is input to all 6 pairs of oscillators, so they all have the same pitch. When two keys are depressed, the key data of the key depressed first is assigned to one VCO on each channel. The key data of any key pressed later is assigned to all of the remaining VCOs. Similarly, VCOs are assigned in order of the last note played. Thus, in the **UNISON** mode six VCOs on each channel are heard at all times.

### SPLIT switch

The **SPLIT** switch determines the maximum number of notes assignable to each half of the keyboard in the split mode.

#### 2/4

In the 2/4 mode, two notes in each channel are assignable to the low range of the keyboard or to the sequencer.

#### 4/2

In this mode, four notes in each channel are assigned to the low range of the keyboard or to the sequencer.

**NOTE:** When the sequencer is programmed to trigger more notes simultaneously than are assigned to the sequencer by the **SPLIT** switch, only the 2 (or 4) notes triggered last by the sequencer are output. Likewise, when playing manually, if more notes are played at once than 2 (or 4, depending on the status of the **SPLIT** switch), last-note(s)-played priority still prevails. This operation is identical to the case where more than 6 notes are depressed simultaneously when in the **NORMAL** mode. The output volume balance of the 4-note side or 2-note side can be controlled with the **BALANCE** 2/4 lever. This lever controls the relative volume of the "2-note" and the "4-note" sections on the keyboard regardless of the position of the **SPLIT** switch.

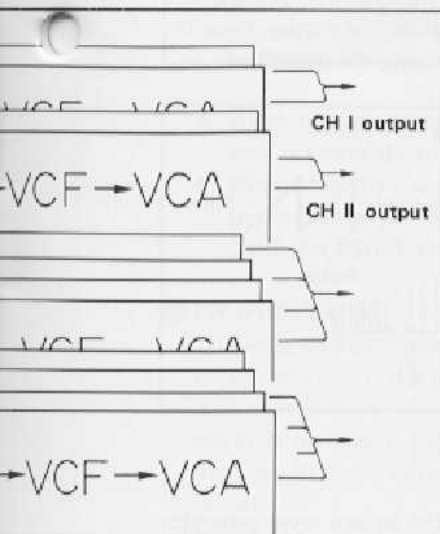
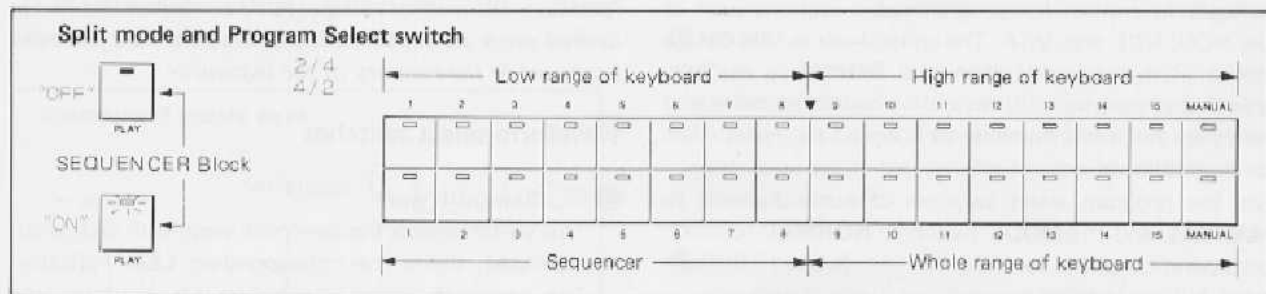

### UNISON MODE (Example of 3 simultaneous notes)

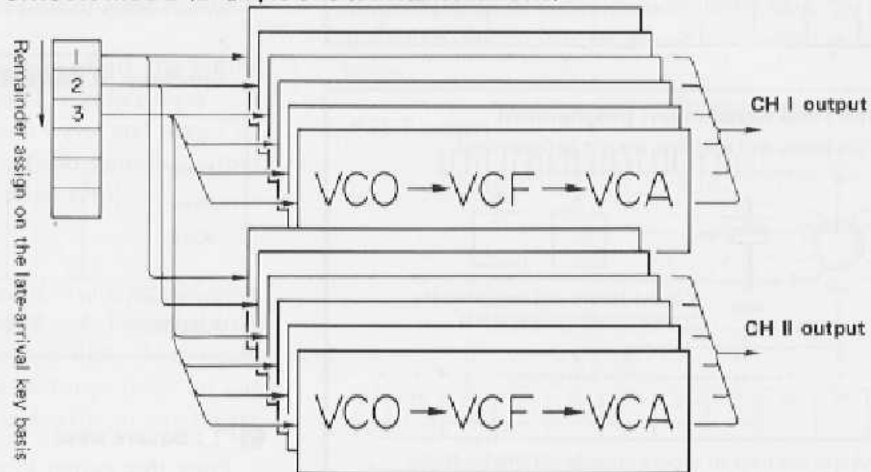

## PROGRAMMABLE PARAMETERS

### ■ Creating Original Sounds

The various controls in this block are the most important to the synthesizer's creative flexibility. They can be used to create a vast spectrum of sounds by controlling the basic blocks of the synthesizer – the VCO, VCF, and VCA.

To get started on creating your own sounds, depress the two **MANUAL** switches at the right-hand end of the row of program selectors, and enter parameters with their respective controls. When the desired sound is completed, store it in the memory. These "sound programs" or "voices" can be called out for later use.

### ■ OPERATION OF PROGRAMMER

The synthesizer is characterized by control of the operation of various blocks such as VCO, VCF, and VCA by DC voltages. Various controls of the CS70M use special elements to generate digital data codes corresponding to their displacements. The computer can directly read this control data and use it for sound generation and storage in the 15 pairs of program memory locations. When recalled by any of the program select switches, the data in the memory is taken out from corresponding place in the memory. The data is converted into DC voltages to control the programmable sections such as the VCO, VCF and VCA. The control values that can be stored in the memory, then, are referred to as "programmable parameters". Note that certain switches and levers are not programmable as it would be meaningless to store their values.

Set the program select switches of both channels to **MANUAL** and the **MODE** switch to **NORMAL** to check the operation of the controls.



#### Levers and switches not programmed

White levers and switches are not programmed.

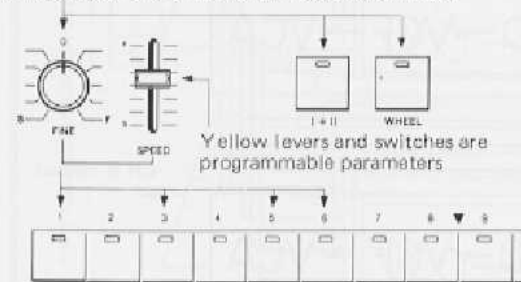

White controls in programmable parameter block can be used in any programs

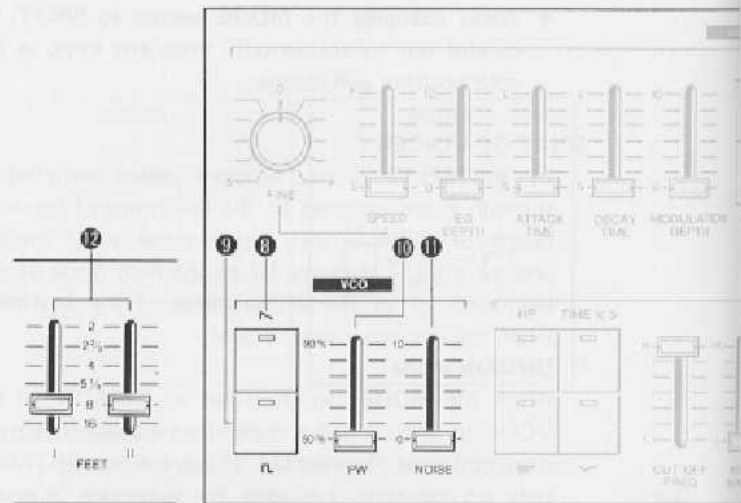

### ■ VCO (Voltage Controlled Oscillator)

Depending on the voltages applied, the VCOs create sound source waveforms of different frequencies (pitches). DC control voltages (CV) corresponding to the desired pitch are input on the basis of the data from the keyboard or the memory of the sequencer.

#### Waveform select switches

#### 8 Sawtooth wave

This switch selects the Sawtooth waveform and, when depressed, lights the corresponding **LED** indicator. The sawtooth wave is effective for imitating the sound of stringed or wind instruments, because it is rich in both odd and even-order harmonics. Press the switch again to turn off the sawtooth waveform.

#### Spectrum of sawtooth wave

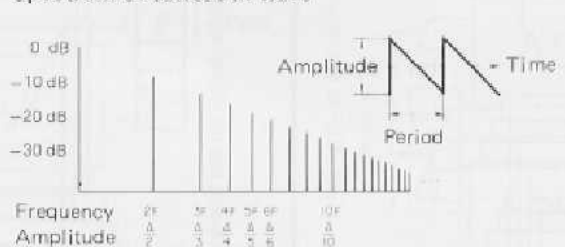

#### 9 Square wave

Press this switch to select the square wave generator as the sound source. The symmetrical square wave is

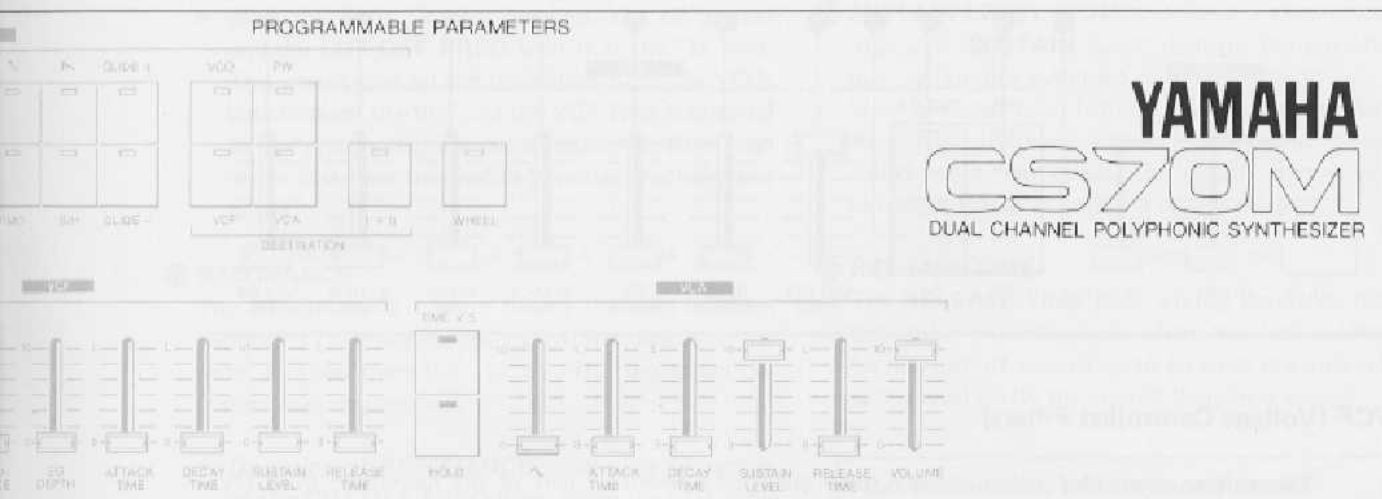

rich in odd harmonics and resembles the timbre of wind instruments such as the clarinet. By changing the duty cycle with the **PW** knob ⑩, even-order harmonics can be added, giving a wide variety of timbres. The ⑧ and ⑨ switches can be turned on simultaneously. In this case, a combination of both waveforms will result.

### Spectrum of square wave

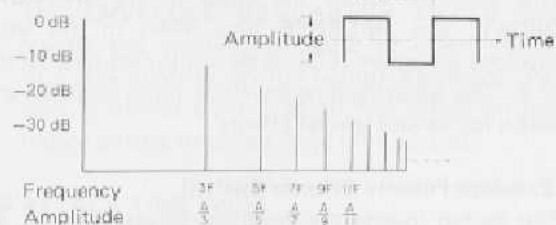

- When the power switch is turned on, the synthesizer is automatically set to  $\square$  : square wave.
- When both the  $\sphericalangle$  (sawtooth wave) and the  $\square$  (square wave) are turned off, no sound is output. (With the **NOISE** lever ⑪ set at zero).

### ⑩ PW (Pulse Width)

This lever changes the pulse width of the square wave. As shown below, the pulse width can be varied from 50% (symmetrical square wave) to 90%. As the pulse width is increased, the wave becomes richer in harmonics, through which various effects can be obtained.

- The **PW** lever operates only when the  $\square$  switch ⑨ is turned on to select a square wave as the sound source waveform. When the  $\sphericalangle$  switch is turned off, no change is made in tone regardless of the setting of this lever.

### ⑪ NOISE

Raise the **NOISE** lever from 0 to 10 to add noise to the sound source. This white noise has uniform frequency components throughout the audio spectrum and is suitable for generating the sounds of wind, waves, trains, etc.

### ⑫ FEET I and II

The **FEET** select switches are located on the lower left part of the panel. The status of the **FEET** switch can be programmed into the memory. The CS70M covers a range of 5 octaves with its 61 keys. By using the **FEET** switch, the range can be changed as shown below.

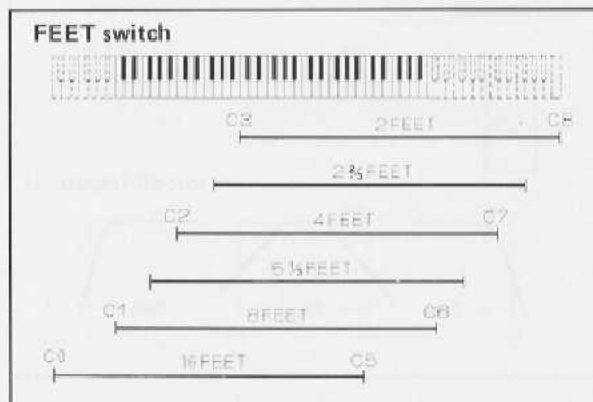

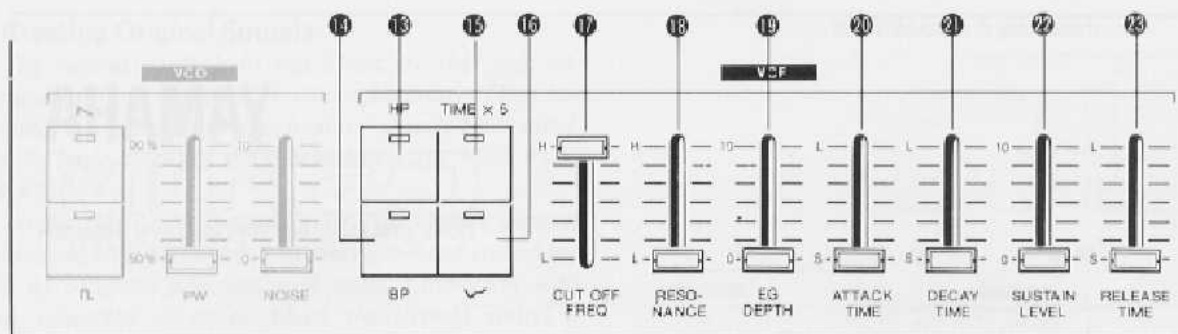

## ■ VCF (Voltage Controlled Filters)

The voltage controlled filters modify tonal quality by removing part of the harmonics from the waveforms generated by the VCOs. The boundary between the part of the signal passing the filter and the part that is cut is called the cut-off frequency. The timbre, or brightness of the sound is controlled by varying the VCF cut-off frequency.

### Filter select switches

These switches select the type of filters used in the VCFs. When both are turned off, the low-pass filters are selected.

#### 13 HP, 14 BP

##### HP (High-Pass Filters)

When the HP switch is on, the VCF functions as a high-pass filter, passing those components of the signal above the cut-off frequency, and blocking those below it.

##### BP (Band-Pass Filters)

When the BP switch is on, the VCF functions as a band-pass filter, allowing only those components of the sound immediately above and below the cut-off frequency to pass through to the VCA.

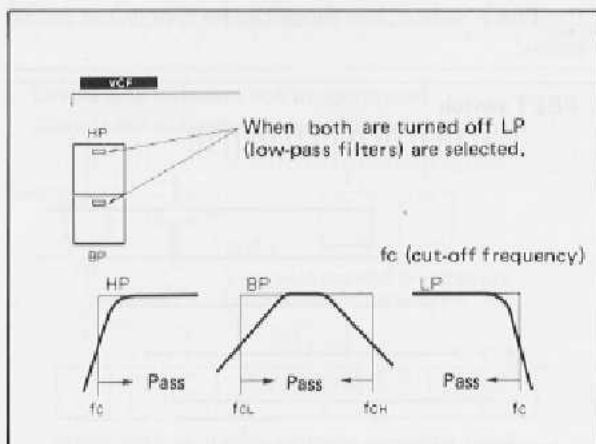

##### LP (Low-Pass Filters)

When the HP and BP switches are both off, the VCF functions as a normal low-pass filter, eliminating only those components of the output of the VCO's which are above the cut-off frequency.

#### 15 TIME X5 Switch

This switch causes the range of the **ATTACK**, **DECAY**, and **RELEASE** time levers in the VCF envelope generator (EG) to be multiplied by a factor of 5. The resulting long envelope times available are useful for various special effects.

#### 16 (Envelope Polarity Selector Switch)

This switch inverts the envelope generator curve, so that positive-going control voltages from the EG become negative, and vice-versa. When in the normal LP filter mode, the switch causes the VCF to function as a high-pass (low-cut) filter.

#### 17 CUT OFF FREQ

This lever raises or lowers the cutoff frequency of the VCF

- When the **CUT OFF FREQ** lever is set at the "L" end of the LP (low-pass filter), all but the fundamental frequencies from the VCOs are cut.

- With the Basic Control Settings, the LP is used and the **CUT OFF FREQ** lever is at the "H" end. This means that all the harmonics from the VCOs pass through the VCF. As the VCF lever is lowered to "L", harmonics are cut in sequence, from high order first, and the timbre becomes gradually less bright.

## 18 RESONANCE

The **RESONANCE** control boosts the level of those harmonics right around the cut-off frequency. As the lever is raised from the "L" to "H", the effect becomes more emphasized.

- Operation of **RESONANCE** varies with the setting of the **CUT OFF FREQ** lever. When the **CUT OFF FREQ** lever 17 is set in the lower half of its range, and the **RESONANCE** lever 18 is raised, the effect becomes more pronounced.

## EG-VCF (VCF Envelope Generator)

The VCF Envelope Generator varies the cut-off frequency of the filter over time. Timbre (filter cutoff) envelopes are controlled by the **ATTACK TIME** 20, **DECAY TIME** 21, **SUSTAIN LEVEL** 22, and **RELEASE TIME** 23 levers.

## 19 EG DEPTH (VCF)

The **ENVELOPE GENERATOR DEPTH** control adjusts the amount, or range of effect of all the VCF EG controls on the cut-off frequency. As the lever is moved from 0 to 10, the effect on the EG timbre change becomes more pronounced.

## 20 ATTACK TIME (VCF)

The **ATTACK TIME** lever adjusts the length of time from the initial depression of a key until the maximum cut-off frequency level is reached. As the **ATTACK TIME** lever is moved from "S" to "L", this becomes longer.

## 21 DECAY TIME (VCF)

The **DECAY TIME** lever adjusts the length of time it takes for the cut-off frequency to go from the maximum it reached at the end of the **ATTACK** time to the **SUSTAIN** level cut-off. Moving the lever toward "L" increases this time period.

## 22 SUSTAIN LEVEL (VCF)

The VCF **SUSTAIN** Level controls the cut-off frequency for the sustained portion of the sound. This lever is moved from 0 to 10, the sustain level cut off frequency becomes higher, giving the sustained sound more harmonics. The cut-off frequency will remain at this level until the note is released.

## 23 RELEASE TIME

The **RELEASE TIME** lever adjusts the decay time — the length of time, from when the note is released, for the cut-off frequency to go from the sustain level to the level set by the cut-off frequency lever.

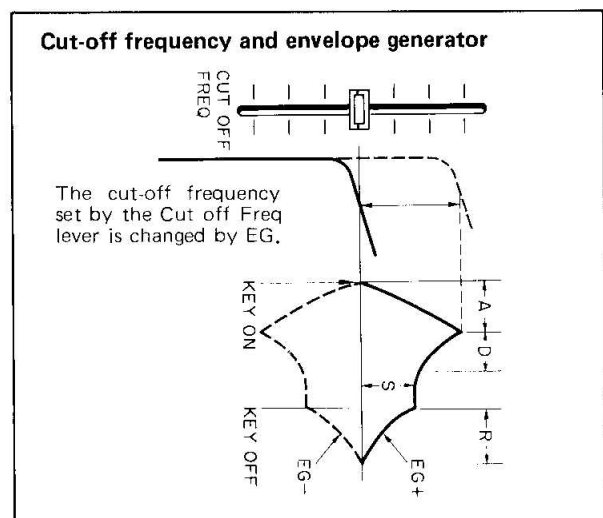

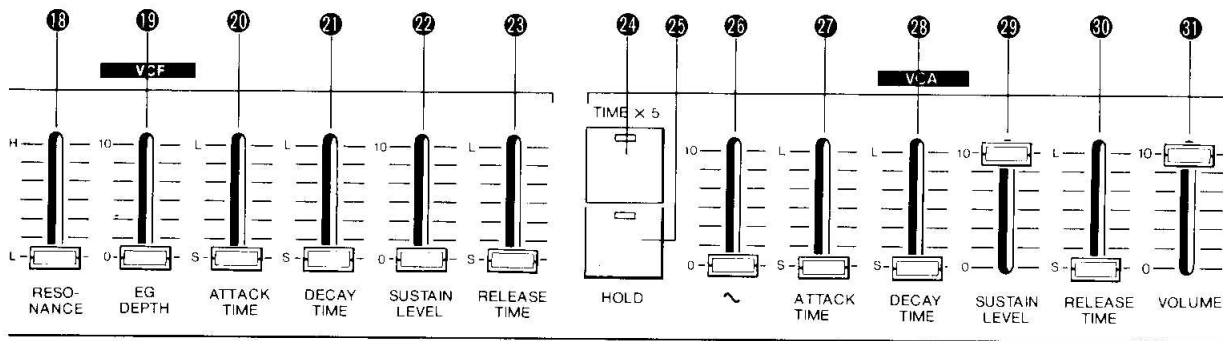

## VCA (Voltage Controlled Amplifier)

The VCA, or Voltage Controlled Amplifier, automatically varies the volume, or loudness, of the notes played, and is controlled by the VCA envelope generator levers.

### 24 TIME X 5

The times 5 switch extends the range of the **ATTACK**, **DECAY**, and **RELEASE** controls by a factor of 5.

### 25 HOLD

The **HOLD** switch automatically "holds" the sound of any notes (up to 6) which are depressed prior to turning on the **HOLD** switch.

By depressing the **HOLD** switch while playing the notes to be held, the VCA's for those notes will continue at their **SUSTAIN** level even after the keys are released, until the **HOLD** button is pressed a second time. If less than 6 notes are held, the remaining notes may be played manually.

- In the split mode, notes in the low range (and notes from the sequencer) may not be held.
- As indicated by its white color, the on/off condition of the **HOLD** switch is not programmable.

### 26 ~ (Input Level)

This lever adjusts the level of the sine wave to be fed to the VCA. Since a sine wave consists of only the fundamental with no harmonics, direct input of this signal may be made from the VCOs without passing through the VCF block.

### 27 ATTACK TIME

The **ATTACK TIME** lever controls the length of time from the initial depression of a key until the maximum volume (output of the VCA) is reached. Sliding the lever from "S" to "L" will cause a gradual lengthening of this time.

### 28 DECAY TIME

The **DECAY** lever adjusts the length of time it takes for the output of the VCA to go from the maximum it reached at the end of the **ATTACK** time to the level determined by the **SUSTAIN LEVEL** control. Moving this lever towards "L" increases this time.

### 29 SUSTAIN LEVEL

The **VCA SUSTAIN LEVEL** control sets the steady state output volume of the VCA for the sustained portion of the sound of the note(s) played. This volume is maintained until the key is released.

### 30 RELEASE TIME

This lever adjusts the time, from when the note is released, for the output of the VCA to go from the **SUSTAIN** level volume to zero.

### 31 VOLUME

This lever controls the overall volume of the VCA's. Because the output level of any patch varies greatly with the settings of the VCF and VCA controls, use this programmable **VOLUME** control to bring the completed sound to a standard level before storing it into memory. This will prevent sudden changes in volume when changing voices in mid-performance, as well as allow programmable balancing of the output levels of Channels I and II.

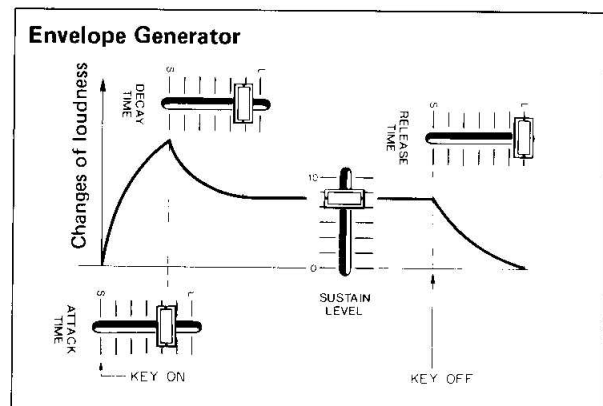



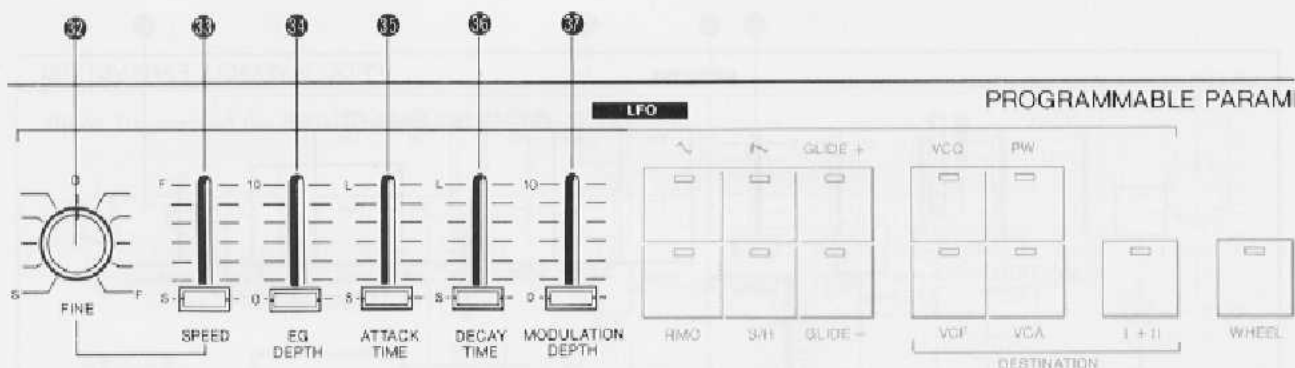

## LFO (Low Frequency Oscillator)

The CS70M features both programmable and non-programmable low-frequency oscillators, designed to produce a broad range of LFO modulation effects. The programmable LFO includes **SINE** and **SAWTOOTH** modulation, plus **GLIDE** (which changes the pitch at the beginning of each note), **SAMPLE & HOLD**, and a **RING MODULATOR**. These various effects are simultaneously assignable to the **VCO**'s, **VCA**'s and to the **PULSE WIDTH** of the square wave.

### 32 FINE

This is a non-programmable fine adjustment knob for the LFO speed. The LFO speed set by the **SPEED** lever 33 may be adjusted over a range of  $\pm 10\%$  with this control. Since this **FINE** control is non-programmable, it can be used to fine-tune the speed of programmed LFO effects on any voice selected by the program memory buttons.

### 33 SPEED (LFO Speed)

This lever is a programmable control used for adjusting the speed of the **LOW FREQUENCY OSCILLATOR** over a range of 0.1 to 100 Hz. Sliding the lever from "S" to "F" increases the speed.

When the **RMO (RING MODULATOR)** is being used, the **LFO SPEED** control adjusts the rate of the modulator signal over a range from 0.5 to 500 Hz. The LFO Speed itself can be modulated over time by utilizing the two-stage LFO envelope generator, controlled by the **ATTACK TIME** lever 35, the **DECAY TIME** lever 36, and the **EG DEPTH** lever 34.

### 34 EG DEPTH

The **LFO EG DEPTH** lever adjusts the amount of modulation to the LFO speed, as set by the LFO envelope generator controls. As this control is moved towards "10", the depth of the change of the LFO speed will increase, and will vary in response to the envelope determined by the **LFO ATTACK** and **DECAY TIME** controls.

When the **GLIDE** functions are being used to modulate the **VCO**'s, the **MODULATION DEPTH** lever 37, rather than the **EG DEPTH** control, governs the

depth of the **GLIDE** effect.

## TWO-STAGE LFO ENVELOPE GENERATOR

These controls generate a two-stage control voltage envelope with variable **ATTACK** and **DECAY**.

### 35 ATTACK TIME

This lever controls the time from the initial depression of the key(s) until the maximum LFO speed is reached. Sliding the lever towards "L" increase the time period. Setting this control to "S" causes the LFO speed to reach maximum instantaneously.

### 36 DECAY TIME

The **DECAY TIME** control adjust the time period over which the LFO speed will decrease gradually, until the original speed as set by the **LFO SPEED** controls is reached.

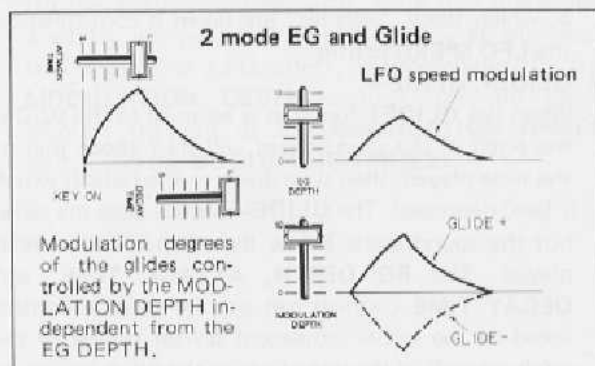

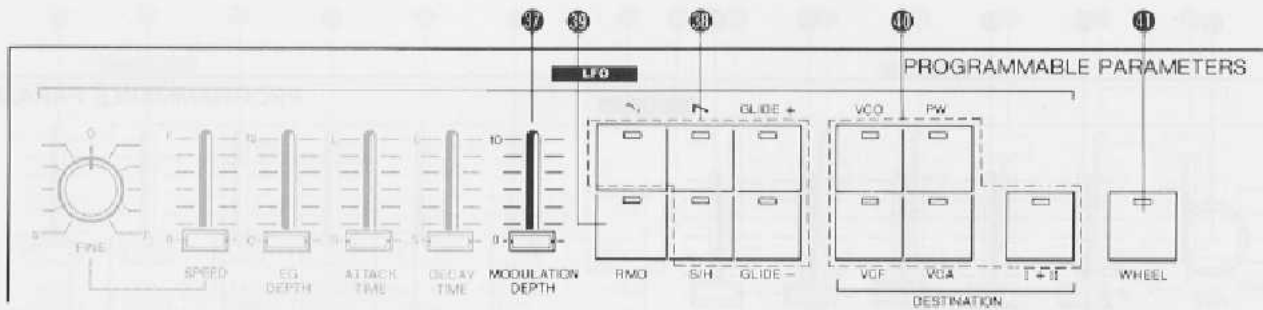

## 37 MODULATION DEPTH

This lever adjust the amount of effect of the LFO waveforms on those parameters selected by the **DESTINATION** switches. The modulation depth of the **RING MODULATOR**, however, may not be adjusted with this control, but is determined by the **LFO ENVELOPE GENERATOR** control.

## 38 S/H, GLIDE+, GLIDE-, (LFO WAVEFORM SELECTION SWITCHES)

These six switches are used to select the type of LFO modulation you wish to use. Only one of the waveforms may be selected.

### □ SINE wave

LFO modulation with a **SINE** Wave causes a vibrato effect when assigned to the VCO's; a "wow-wow" sound when assigned the VCF's, and a tremolo effect when modulating the VCA's.

### □ SAWTOOTH wave

The **SAWTOOTH** wave is particularly effective when assigned to the VCO's, giving a repeated, falling pitch sound when the note(s) are played.

### □ S/H (SAMPLE AND HOLD)

The CS70M's **SAMPLE AND HOLD** generator samples the output of the white **NOISE** generator to create random control voltages. When these are applied to the VCO's, notes play at random pitches. When modulating the VCF's, random, varying cutoff frequencies are heard as notes are played. The speed at which these "samples" are taken is controlled by the **LFO SPEED** control.

### □ GLIDE+, GLIDE-

When the **GLIDE+** function is assigned to the VCO's, the pitch of the sound heard will start **above** that of the note played, then slide down to the note(s) which is (are) depressed. The **GLIDE-** button does the same, but the sound starts **below** the pitch of the note(s) played. The **EG DEPTH**, **ATTACK TIME**, and **DECAY TIME** controls can also be used to control speed of the initial movement up (or down) of the pitch, as well as the **rate** at which the pitch returns to

that of the note played. Finally, the **MODULATION DEPTH** control determines the overall amount of pitch change when using either **GLIDE** function,

## 39 RING MODULATOR

When the **RMO (RING MODULATOR)** switch is on, the sum and difference between the frequencies of the note(s) played and that of the LFO (a sine wave with a 0.5 to 500 Hz range) is produced. This causes a metallic, ringing type sound, useful for creating the sound of bells, gongs, etc. Since the tone of the ring modulated sound is determined by the **LFO SPEED**, the **EG DEPTH**, **ATTACK TIME**, and **DECAY TIME** controls will alter the **RING MODULATOR** effect. The **MODULATION DEPTH** control also affects the sound when the **RING MODULATOR** is routed to the VCF's or the square wave **PULSE WIDTH**.

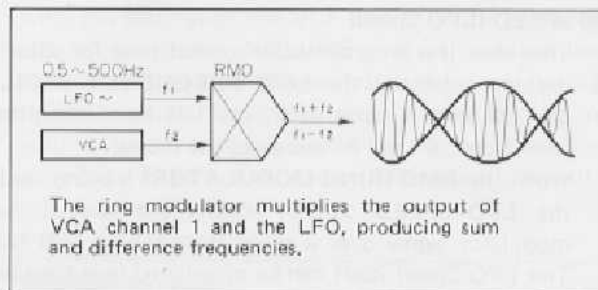

Press any of the other switches to turn off the RMO.

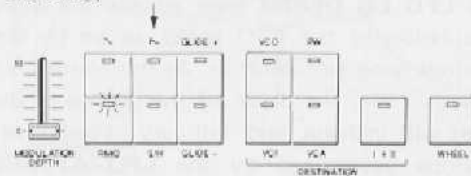

Set DEPTH to "0" or turn off DESTINATION.



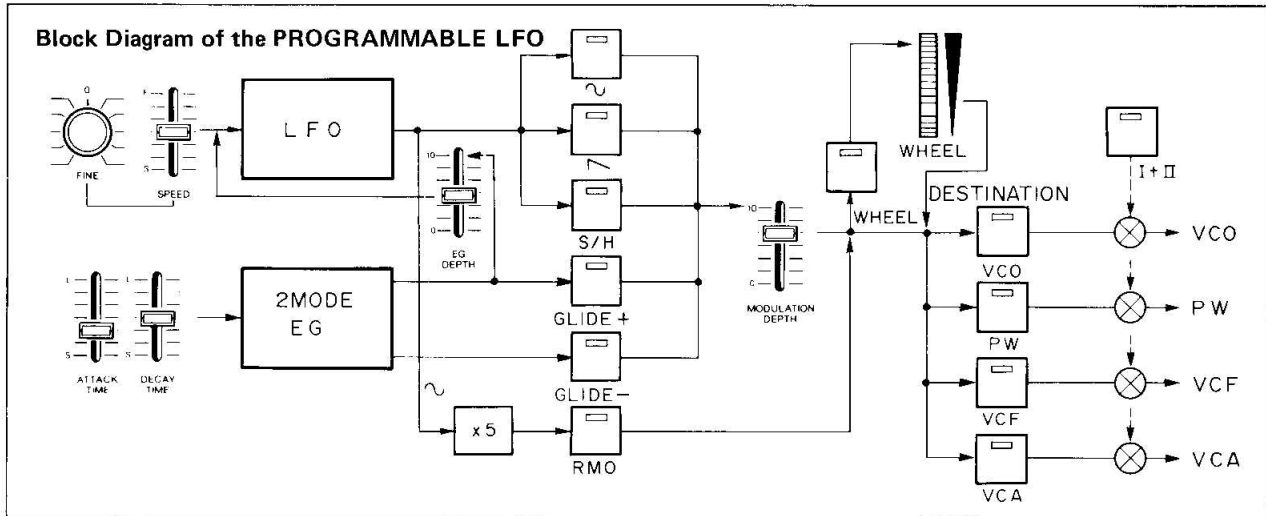

## 40 DESTINATION SWITCHES

These switches are used for selecting the one or more sound parameters to be modulated by the LFO: VCO's, VCF's, square wave **PULSE WIDTH**, and the VCA's. When any voice is recalled by depressing the voice select buttons, the waveform and **DESTINATION** switches which were part of the Channel I program will be illuminated.

- **VCO (VOLTAGE CONTROLLED OSCILLATOR)**  
When the LFO function is routed to the VCO, the pitch of the note(s) played will vary according to the waveform selected and the **LFO SPEED** controls. **SINE** wave modulation of the VCO's gives a vibrato effect.
- **PW (PULSE WIDTH)**  
The **PULSE WIDTH** of the square wave as set by the **PW** lever 10 is varied by the LFO waveform when the **PW DESTINATION** switch is selected. There will be no effect if the voice being programmed employs only the sawtooth or sine waveforms on the VCO's.
- **VCF (VOLTAGE CONTROLLED FILTER)**  
When the **VCF DESTINATION** switch is depressed, the effect of the LFO will be routed to the VCF's causing the cutoff frequency to be varied according to the waveform selected and the **LFO SPEED** control.

- **VCA (VOLTAGE CONTROLLED AMPLIFIER)**

Using the **VCA DESTINATION** switch causes the volume of the sound produced to vary with the LFO waveform and speed setting. **SINE** wave modulation of the VCA's gives a tremolo effect.

- **I + II Switch**

This switch is a **non-programmable** control which assigns the effect of the LFO to both Channels I and II. When this button is not illuminated, the programmable LFO will modulate the VCO's, VCF's VCA's, and **PULSE WIDTH in Channel I only**. The **PROGRAMMABLE LFO**, then, cannot be assigned to just Channel II. The non-programmable LFO (see page 29), however, can be assigned to Channel I only, Channel II only, or both.

## 41 MODULATION WHEEL SWITCH

When this switch is turned on, the amount of LFO modulation, as programmed by the LFO controls, can be increased with the **MODULATION WHEEL** (to the left of the keyboard). Note that this is also a white, non-programmable control – at any time, the amount of LFO effect, as programmed by the **MODULATION DEPTH** control, can be varied through the use of the **MODULATION WHEEL** switch and the **MODULATION WHEEL**.

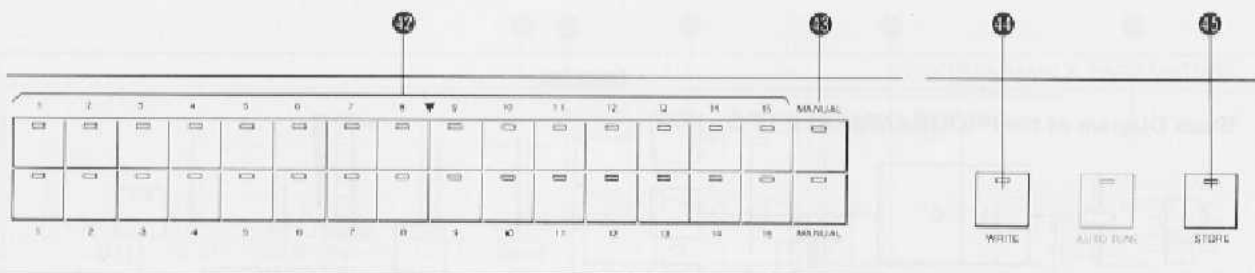

## PROGRAMMABLE PARAMETERS

The CS70M programmable memory section allows you to save the voices you have created for later recall at the touch of a button. All programmable parameters may be written simultaneously into the memory with the **WRITE** button, and this stored data may be recalled through the use of the fifteen pairs of program memory buttons. Individual parameters of any particular memorized sound may be easily altered by entering the **EDIT** mode (by depressing the program memory button of the voice you wish to change).

All the voicing data stored in the program memory locations will not be lost even if the power switch is turned off, due to built-in back-up batteries for the memory (battery life is approximately two years). Voices stored in the CS70's memory may then be permanently saved on magnetic voice cards for an infinite amount of sound storage capability (**STORE**). These magnetic cards can be reloaded into the CS70M's memory at any time (**LOAD**), allowing the performer to quickly and easily change any one or more of the voices in the program memory locations.

### 12 PROGRAM SELECTION switches 1 ~ 15

Each **PROGRAM SELECT** switch controls access to one program memory location in which the programmable parameter data is stored. The upper row of buttons recall the Channel I data; the lower row is for Channel II.

### 13 MANUAL switch

The grey **MANUAL** switches put all the programmable parameter sliders and buttons under full manual control from the panel. This mode is used for all setting of the front panel programmable controls (except for when you are in the **EDIT** mode). Note that there are two **MANUAL** buttons – one for each channel – but only one set of controls. Thus, when both **MANUAL** buttons are on, the front panel controls will determine the sound of both Channels I and II identically (except for the programmable LFO when it is not assigned to I + II).

### 14 WRITE switch

The **WRITE** switch is used for 1) transferring the information on the programmable control settings to any one of the program memory locations, and

2) for transferring voice data from any one program memory to another.

### 15 STORE switch

The **STORE** switch is used to record data in the program memories onto the magnetic voice cards.

### 17 PGM (PROGRAM LOCK switch, rear panel)

When this switch is **on**, the program memories are set up for read-only operation. In this mode, no new programs can be written into any of the program select locations from the **MANUAL** or from the voice cards.

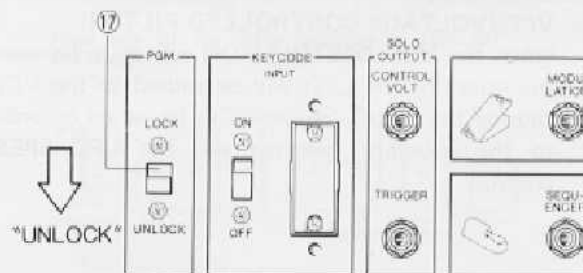

## PROGRAMMING PROCEDURE

### WRITE — Creating a voice and writing into memory

1. Check that the **PGM LOCK** switch on the rear panel is set to "Unlock".

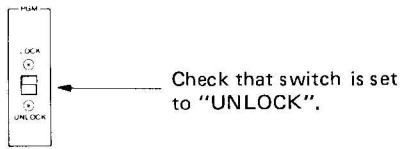

2. Turn on the grey **MANUAL** switch ④ corresponding to the channel being programmed.

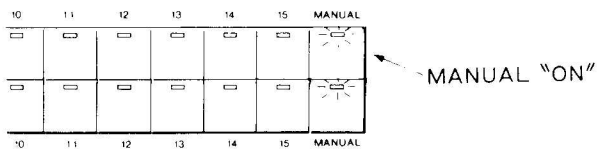

3. Adjust the front panel programmable controls to create your sound.
4. Once you have completed your programming, depress and hold the **WRITE** switch ④, then depress the program memory button to save your voicing data in the memory location of your choice.

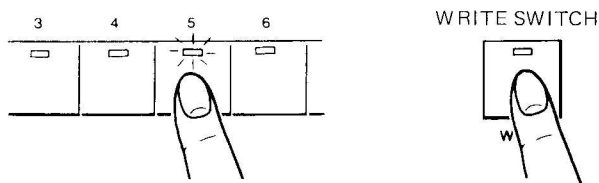

While depressing the WRITE button, push the program selector

- Pushing a program select button twice causes its indicator to flash showing that the **EDIT** mode (described in the following) is active. Pushing the program select button again deactivates the **EDIT** mode and the indicator stops flashing.

### CALL — Recalling a previous programmed voice

1. Depress the program selection switch of the desired voice.

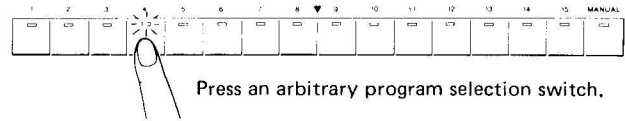

- It doesn't matter if the PGM switch is set to "LOCK"

1. If you are in the **NORMAL** mode, two program memory voices may be selected, one for the **CHANNEL I** output, the other for **CHANNEL II**. If you are monitoring the output of the CS70M in stereo, these two voices will be heard in separate channels.
2. When the **MODE** switch is set to **SPLIT**, any two program memory buttons in the 1 ~ 8 group and any two program memories in the 9 ~ 15 group can be selected simultaneously. These voices, then, will correspond to performance in the lower and upper ranges of the keyboard, respectively.
3. If the **SEQUENCER** is in use (**PLAY** button on), the sequencer will play back the contents of its memories with the program memory voices from the 1 ~ 8 group, and the entire keyboard may be manually played, and the sound of the voice chosen from the 9 ~ 15 will be heard. (With a total no more than six simultaneous notes, of course — see **MODE 7**).
4. When the power switch is turned on, or if the **MODE** switch is moved from **SPLIT** to **NORMAL**, the two program memory buttons under the number 1 will automatically be selected. When the **MODE** switch is changed to **SPLIT**, the switches under both the numbers 1 and 9 will be activated.

### EDIT — Modifying an existing voice

1. Check that the **PGM LOCK** switch on the rear panel is set to **UNLOCK**.
2. Check that the channel which you do not intend to edit is **not** in the **MANUAL** mode (with the **MANUAL** button on, rather than one of the program memory buttons).
3. Depress and release the program memory button of the voice which you wish to alter (same as the **CALL** procedure).
4. Depress the switch a second time — the **LED** indicator should now be flashing, showing that the voice is in the **EDIT** mode. Note that when in this mode, pressing any one of the other program memory buttons calls that voice, and cancels the Edit function.

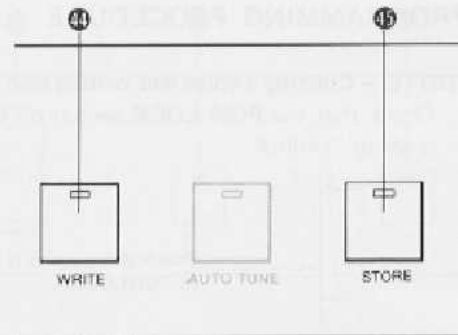
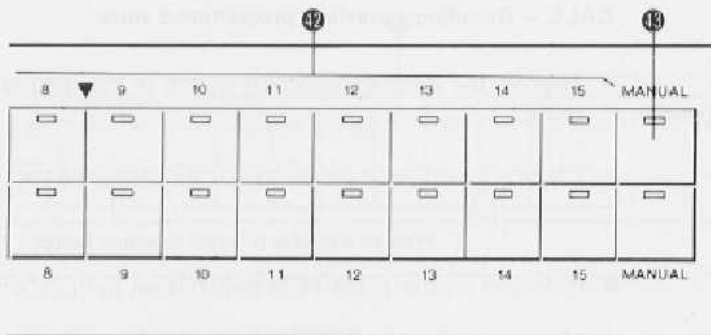

5. Modify the voice as desired: only the programmable parameters the controls of which you actually reposition when in the **EDIT** mode will be affected – all other parameters will remain as they were originally programmed into the program memory location. It is recommended that you set the **BALANCE** I/II lever so that only the voice which you are modifying is heard.
6. When in the **EDIT** mode, the CS70M's microprocessor checks the amount of movement of each control and adds the change to the stored data. In some instances, it may occur that moving any one control to one end of its range may not give you the full amount of change you desire.

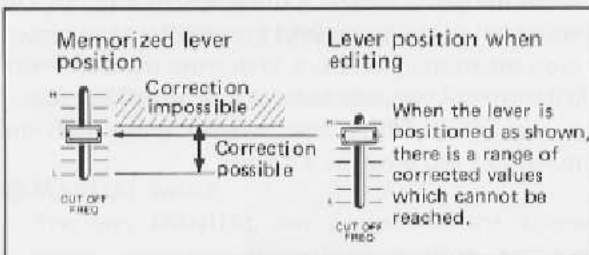

In this case, slide that control back to the other extreme of its movement, and the control will revert to normal operation as in the **MANUAL** mode. The **FEET** switch is an exception, in that it will operate as if in the **MANUAL** mode as soon as it is moved.

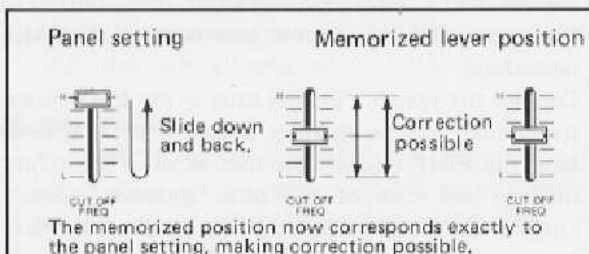

7. Once all modifications of the control settings in the **EDIT** mode have been carried out, there are three options available:
  - a. If you want to play the voice which has been modified only temporarily, you can leave that voice in the **EDIT** mode (the indicator will still be flashing). Returning the **BALANCE** I/II control to the middle area of its range will, of course, combine your newly edited voice with the sound selected by the program memory button in the other channel. If you again depress the button which is flashing, **OR**, if you select any other program memory in that channel, the **EDIT** mode will be cancelled, and the modifications you made to the sound will be erased.
  - b. If you wish to replace the original sound with the new voice created by modifications made in the **EDIT** mode, simply depress the flashing program memory button while holding down the **WRITE** button. The original control settings will be lost, and the new sound will be stored in this memory location. (You may, of course, save all voice data for later use on the magnetic voice cards – see the following section).
  - c. If you wish to retain both the original sound and the modified version, depress one of the other program memory buttons while holding the **WRITE** button. Although this will erase any settings previously stored in that location, it will allow you to retain in memory both the original sound and the new sound which you programmed while in the **EDIT** mode.

## VOICE LIBRARY SYSTEM

Although the CS70M's internal memory offers storage of 30 different voices, the magnetic voice card system gives you unlimited storage of your programs. Any sound can be digitally stored on external magnetic memory cards via the built-in card reader/writer (located below the upper end of the keyboard). Since one card provides space for the programmable parameter data for two sounds, the entire internal memory can be retained on just 15 cards. Another advantage of the voice card system is the ability to load back into the program memory locations just **one** voice, whereas in other external memory systems, all the memories have to be reloaded to change just one or a few of the sounds. Also, the voice cards make it possible to read the program data for a sound which was created in **CHANNEL I** into **CHANNEL II**, and vice versa.

### STORE – Recording voice data on magnetic cards

The programmable parameter data for one voice may be recorded on each "side" of the magnetic voice cards (marked "A" and "B"). Storing program data on a card on which some other sound has already been written erases the previous data. If the corners of the magnetic card are cut off, however, the data is protected, and no further voices can be written on the card. (This is quite similar to the plastic "non-record" tabs on a standard audio cassette tape.)

### TO STORE A PROGRAM ON THE MAGNETIC CARDS:

1. Insert the card into the reader/writer below the upper end of the keyboard. Any lit **LED** indicators on the program memory buttons will now turn off.

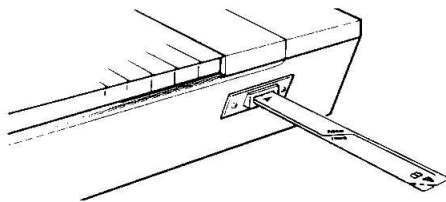

2. While holding down the **STORE** button, depress the program memory button of the program which you want to write on the card. This will start the card reader's drive motor.

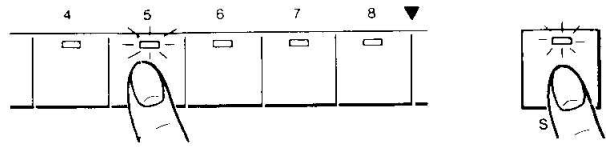

3. Insert the card slightly further into the card reader.

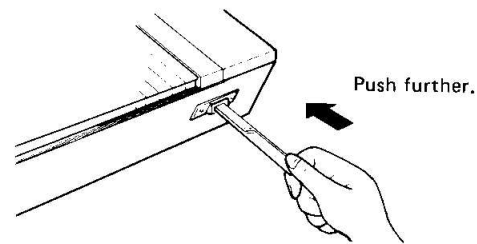

4. The card will go in and out twice – once to write the data, a second time to read the card to insure that the data was written correctly. If any bit errors occur (incorrect data transfer), the program memory **LED** will flash quickly. Remove the card and repeat the **STORE** procedure. If the **STORE** function cannot be accomplished a second time, there may be a defect on the magnetic surface of the card – in this case, use a different magnetic voice card.

5. When the **STORE** process is successfully completed, the **LED** indicator on the program memory location which was written to the card will again be lit. Remove the loaded card. You can make a note of the voice which was loaded on the white surface of the card with a hard-lead pencil or a non-water-soluble felt-tipped pen.

### NOTE – Care of the magnetic voice cards

1. Do not bend or fold the voice cards.
2. Protect the magnetic surface from scratches.
3. Do not place the voice cards in any strong magnetic field.
4. Keep the cards in **YAMAHA VOICE LIBRARY** holder when not in use.

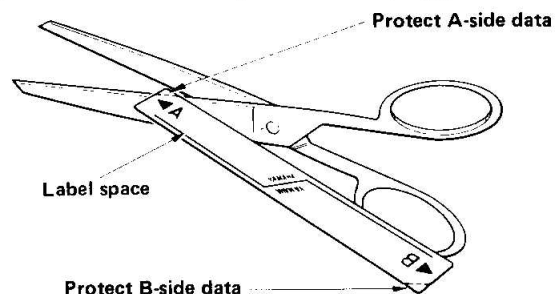

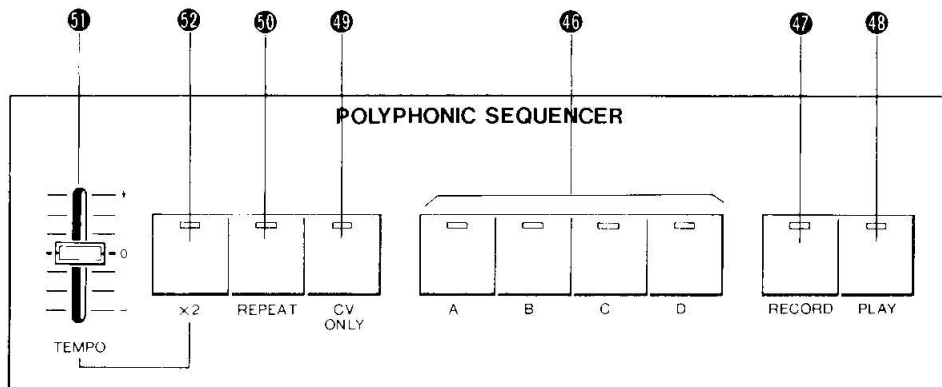

### LOAD – Reloading the magnetic voice cards

1. Check that the **PGM LOCK** switch is set to **UNLOCK**.
2. Insert the voice card into the reader/writer. The program memory **LED's** which were illuminated will now go off, and the keyboard will not trigger the **VCO's**.
3. Press the program memory button of the memory location into which you want to transfer the voice data.

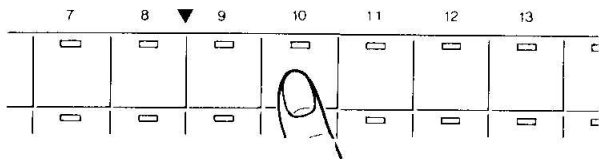

4. Insert the card slightly further into the card reader.
5. The card will be read and returned, and the **LED** indicator will again be lit. Remove the card. If a data error occurs during the loading process, the **LED** on the program memory button will flash quickly: remove the card and perform the **LOAD** procedure again. If the card will not load when tried a second time, the magnetic voice card may be defective, or the data on the card may have been scrambled by a magnetic field. Try another card to insure that the card reader is operating properly.

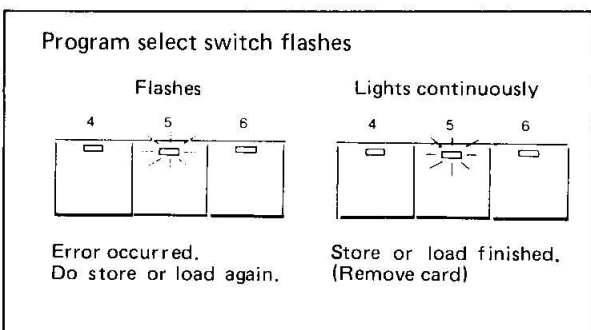

### POLYPHONIC SEQUENCER

The **POLYPHONIC SEQUENCER** is a sophisticated system that functions almost like an extra pair of hand in live performance situations. Each of the four Sequencer memory banks can store separate note/rhythm patterns – all with six-note polyphonic capability. The **SEQUENCER** functions in a manner just like the keyboard: it provides multiple control voltage and trigger information to the **VCO's**, **VCF's** and **VCA's**. The two channel/six note function of the **CS70M** is shared by the keyboard and the **SEQUENCER**, and this allocation is determined by the **MODE** switch ⑦. Although the sequencer pattern data loaded into the **SEQUENCER** can be played repeatedly while the **CS70M's** power is on, this data will be lost when the power is switched off (unlike the program memory data, which is "non-volatile").

#### ④⑥ A, B, C, AND D BANK SELECTION SWITCHES

These switches select the memory bank into which you want to load a sequence pattern. Each bank has a capacity of 128 "steps", one step being the amount of memory used when a single note is played into the sequencer (see page 26 – Number of Steps). In addition to the ability to utilize each sequencer bank independently, two or more banks can be connected for recording even longer sequences.

#### ④⑦ RECORD SWITCH

After pressing one or more of the **BANK SELECTION** switches and then the **RECORD** switch, all notes played on the keyboard will be recorded into the **SEQUENCER** memory. Recording will start when the first key is pressed after the **RECORD** switch is turned on (**LED** illuminated), and will stop when the **RECORD** switch is pressed again. Note that when stopping the record mode, if you press the **RECORD** switch in **rhythm** with the sequence you are playing (i.e., on the next "beat" after the last note entered), the resultant starting and stopping points of the sequence will be "in time" when playing the sequence back with **REPEAT** ⑤①.



## 48 PLAY SWITCH

Pressing the **PLAY** switch starts the playback of the **SEQUENCER** data in the one (or more) memory banks which are **on**. Playback will stop when (a) all recorded material has been played, or (b) when the **PLAY** switch is pressed a second time. The **LED** on the **PLAY** switch will go out when the **PLAY** mode is over.

If the optional **FC-4** foot switch is connected to the **FOOT SWITCH** connector on the rear panel, sequencer playback can be turned on/off with the foot switch. The **PLAY** button must be turned **on** initially in order to utilize the foot switch, however. To repeat playback of a sequence, use the **REPEAT** switch 50.

## 49 CV ONLY

The **CV ONLY** switch allows note (without rhythm) patterns to be recorded by the **SEQUENCER**, and played back at a constant rate determined by the **TEMPO** lever and the x2 switch. This function is particularly useful when the sequence to be loaded is more complex and difficult than the player can accomplish. In addition, when playing back single note lines recorded in the **CV ONLY** mode, the distinctive analog sequencer type sound results. To record in the **CV ONLY** mode, first select one or more memory banks, press the **CV ONLY** button, and then the **RECORD** switch. To record the note entries, press the **CV ONLY** switch while **holding down** each key(s) in the sequence. See page 27 for complete instructions on recording with **CV ONLY**.

## 50 REPEAT SWITCH

The **REPEAT** switch allows any sequence to be played back over and over again continuously, as long as the **PLAY** switch is on. If more than one memory bank is selected for playback, this switch will also cause the contents of all memories selected to repeat. The **REPEAT** switch can be depressed before or during the playback of a sequence, and the patterns will continue repeating until the **PLAY** switch is turned off.

## 51 52 TEMPO, x2

When the x2 switch is off, and the **TEMPO** lever is set at the center line of its range, the playback speed will be the same as the speed at which the sequence was recorded. Moving the **TEMPO** lever towards the "+" will increase the playback speed—moving the lever the other way will decrease the speed. Turning on the x2 switch will cause the range of the **TEMPO** lever to be multiplied by a factor of 2, thus greatly increasing the possible playback speeds. If your sequence was recorded in the **CV ONLY** mode, the **TEMPO** and x2 controls will determine the playback speed.







## PLAYBACK IN SPLIT MODE

When recording a sequence, the **POLYPHONIC SEQUENCER** will memorize all notes depressed regardless of the position of the **MODE** switch. On playback, however, the number of notes produced is limited by the **MODE** switch 7. For example, if a polyphonic note pattern is played back in the 2/4 mode, only two notes out of a possible six recorded will be heard at the output, with the note selection by the **SEQUENCER** on a last-note-played basis. This mode is identical to the situation in which a chord of more than two notes is played on the left side of the keyboard when in the 2/4 mode. Remember that when playing back a sequence in the **SPLIT** mode, the program memory switches selected for the left side of the keyboard are assigned to the sequencer, regardless of the location of the split point, and the 2/4 **BALANCE** lever will now control the relative volume of the sequence and your manual play. (See page 12.) Also note that when playing a sequence (in any mode), the Programs selected may be changed **during** the playback, as well as the settings of any real-time controls (See page 28).

## SEQUENCER MEMORY CAPACITY

When recording a sequence, the number of "steps" in the memory consumed is **roughly** equal to the number of notes depressed. Unless you are recording in the **CV ONLY** mode, the timing, as well as the note entries, use up the sequencer's memory. During the record mode, the **LED** on the memory bank button which is selected will flash on and off when the number of steps remaining in that bank is **12 or less**. Thereafter, when there are no steps of memory left, the indicator will go out, and the sequencer will automatically go out of the **RECORD** mode. If you already selected more than one Memory Bank before initiating the **RECORD** process, your entries will be recorded in the next bank upon depleting the memory capacity of the first bank. Thus, very long polyphonic note/rhythm patterns may be recorded by selecting all four memory banks when recording.

### Capacity of the Sequencer Memory

Score						
Steps	1	2	3	3	0	0

## Recording Procedure – Note/Rhythm Mode

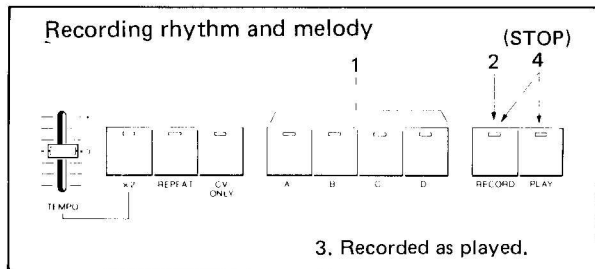

1. Select one or more memory bank switches. You cannot select additional memories once the **RECORD** button is depressed. therefore, be sure to choose sufficient memory for the sequence you wish to load before initiating the **RECORD** mode.
2. Press the **RECORD** switch.
3. Start playing the keyboard – the time from turning on the **RECORD** button until the first key is depressed is not recorded.
4. When recording is completed, press the **RECORD** switch again to end the **RECORD** mode. If playback in the **REPEAT** mode is anticipated, be sure to hit the **RECORD** button in time with the passage you are playing.

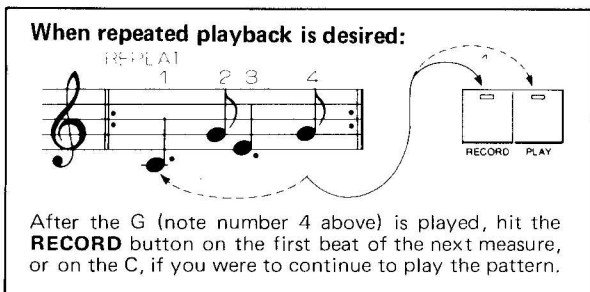

The longest note or rest which can be recorded with the polyphonic sequencer is about 10 seconds. If a key is pressed for a longer time than that, or if no key is depressed for this period of time, the record mode is automatically cancelled.

## CV ONLY RECORDING

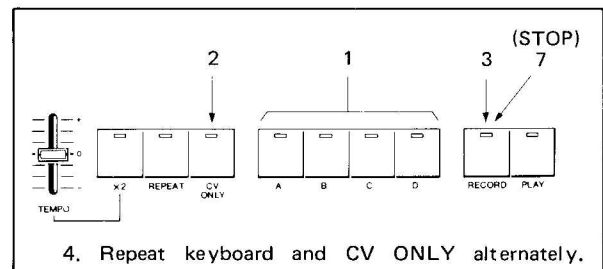

1. Select one or more memory bank switches.
2. Press and hold the **CV ONLY** switch, then depress the **RECORD** switch. Be sure to press the **CV ONLY** switch before the **RECORD** switch – if the **RECORD** switch is pressed first, the normal note/rhythm mode will be selected.
3. While playing (and holding down) the note or chord to be recorded press and release the **CV ONLY** switch.
4. While holding the next note or chord in your sequence, press and release the **CV ONLY** switch.
5. When a rest (which, upon playback, will have equal time value with any notes in the sequence), press only the **CV ONLY** switch.
6. Repeat this operation for every step in the sequence you wish to program.
7. Hit the **RECORD** again to end the recording mode.

The following diagram shows an example of the loading of a **CV ONLY** sequence.

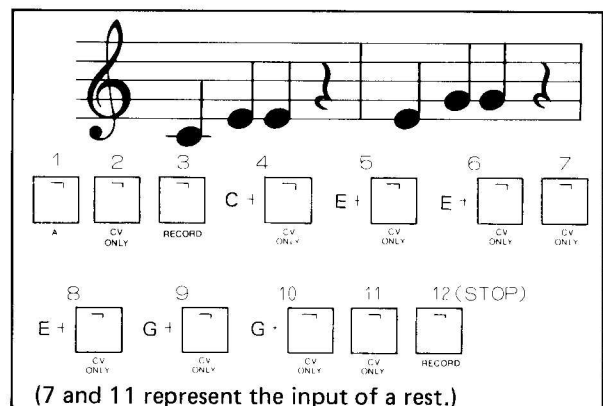



## SEQUENCE PLAYBACK

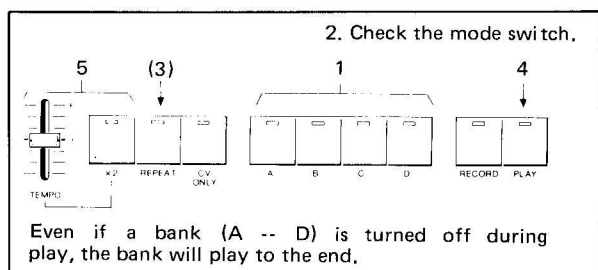

1. Select one or more memory banks to be played. If more than one bank is selected, playback will be in turn (alphabetically, from left to right). If multiple banks were used to record a long sequence, you will want to select all those banks for the playback of that sequence.
2. Check the setting of the **MODE** switch ⑦. If you have it set to **SPLIT**, select the program memory buttons for the voices which will be heard from the sequencer playback.
3. If repeated playback of the sequence (or sequences, if more than one memory bank is selected), press the **REPEAT** switch ⑩.
4. Press the **PLAY** switch.
5. Adjust the playback tempo with the **TEMPO** lever and/or the x2 switch.
6. To end playback, press the **PLAY** switch a second time.

Note that when playing back a sequence in the **SPLIT** mode, the split point itself is not in affect, i.e., the sequencer as well as manual play is possible over the entire keyboard, with the number of notes playable determined by the 2/4 switch. When the **PLAY** switch is hit again, ending playback, or when the sequence is over, the keyboard will revert to the normal **SPLIT** mode operation.

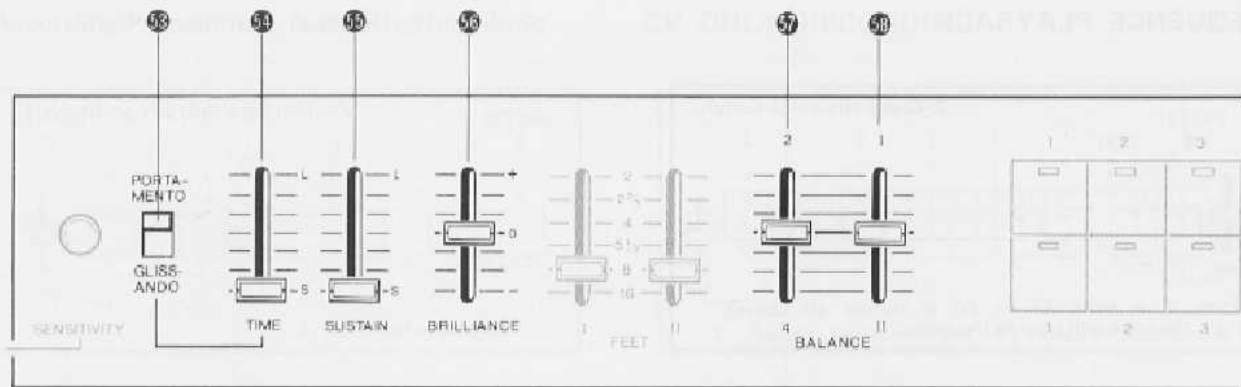

While the basic tonal quality of the CS70M is determined by the programmable controls, various non-programmable "real-time" controls are provided for additional modulation, filter, volume, and several special effects. (For the FEET switch, ⑤, see page 14).

## ⑤③ PORTAMENTO/GLISSANDO

This switch selects either **PORTAMENTO** or **GLISSANDO**. Portamento is a smooth "slide" from one note or notes to another, whereas glissando gives a half-step at a time pitch change, like playing a chromatic scale. In the **SPLIT** mode, portamento and glissando are not in effect on either the lower part of the keyboard, or on the sequencer, if it is in playback.

## ⑤④ TIME lever

This lever adjust the rate of change of the pitch effected by either **PORTAMENTO** or **GLISSANDO**. As the lever is moved toward the "L", this change become slower.

If you do not wish to have any **PORTAMENTO** or **GLISSANDO**, this lever should be set all the way to "S". If a foot switch (FC-4) is connected to the **PORTAMENT** jack on the rear panel, the portamento or the glissando effect can be turned on and off via this switch, and the rate can be controlled by the **TIME** lever.

## ⑤⑤ SUSTAIN lever

The **SUSTAIN** allows the player to extend the time for the notes to decay after releasing the keys beyond that set by the **RELEASE** lever of the **VCA** block. Because this is a real-time control, release can be controlled quickly and easily to suit the musical situation. As the lever is moved toward "L", the sustain time becomes longer.

If a foot switch (FC-4) is connected to the **FOOT SW SUSTAIN** jack on the rear panel, the sustain effect can be turned on and off with the **SUSTAIN**

lever controlling the release time. To turn off the effect when not using the foot switch, move the lever all the way to "S".

## ⑤⑥ BRILLIANCE lever

The **BRILLIANCE** allows fine adjustment during performance of the **VCF** cutoff frequency. Just like the **CUTOFF FREQ** lever in the **VCF** block, moving the lever upwards (towards the "+") raises the cutoff frequency, giving a brighter tone richer in harmonics. During programming of voices in the **MANUAL** or **EDIT** modes, it recommended to keep the **BRILLIANCE** lever in the center, zero position.

Note that the **BRILLIANCE** lever effects the tonal quality of both channels.

Note that the **BRILLIANCE** lever works in the same manner as the **VCF CUTOFF FREQ** control, therefore it adjusts the tonal quality of the sound according to the **VCF** mode – **LOWPASS**, **BANDPASS**, or **HIGHPASS**.

## BALANCE lever

### ⑤⑦ 2/4 SPLIT BALANCE lever

This control adjust the relative volume between the 2-note and the 4-note portions of the sound when in the **SPLIT** mode, or between the sequencer playback and manual play when the sequencer is in **PLAY**. Note also that this lever operates as indicated regardless of the position of the 2/4 switch.

### ⑤⑧ CHANNEL I/II BALANCE lever

This control adjust the relative volume between the **CHANNEL I** and **CHANNEL II** signals, and functions the same whether you use the **MIXED** or separate output jacks (page 6).

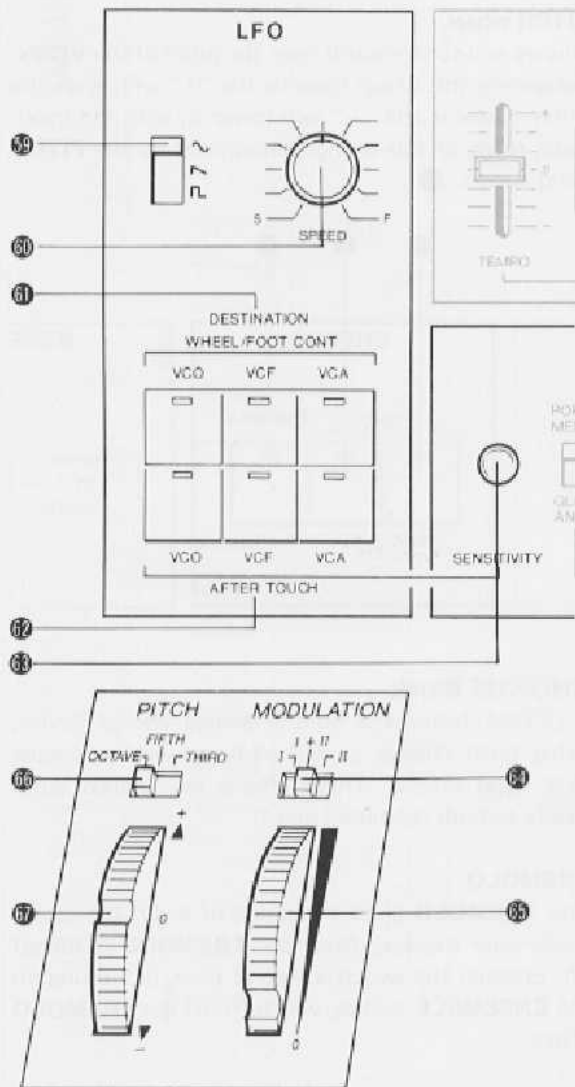

### 59 LFO Waveform Selector

This switch selects the type of waveform for different **LFO** modulation effects: sine, sawtooth, or square wave.

### 60 SPEED Control Knob

This controls the speed (frequency) of the **LOW FREQUENCY OSCILLATOR**. As the knob is turned from "S" to "F", the speed increases, with a range from 0.05 to 50 Hz.

### 61 DESTINATION (Wheel/Foot Control)

The **DESTINATION** switches determine the routing of the **LFO** signal. If the **VCO**, **VCF**, or **VCA** switch is pressed, the **LED** will light, indicating that the **LFO** is now modulating that block. Multiple destinations can be selected by pressing two or more of these switches. The modulation depth is controlled by means of the **MODULATION WHEEL**, or, if a foot controller is connected to the **MODULATION** jack on the rear panel, the wheel is disabled, and the depth of the **LFO** effect is determined by the foot controller.

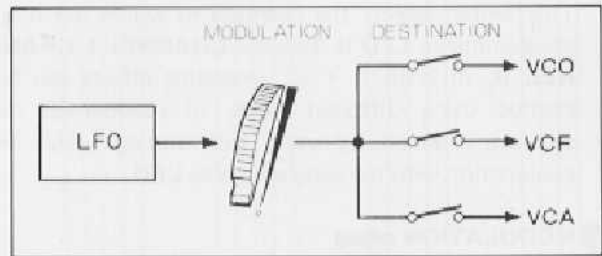

### AFTERTOUCH

The CS70M's **AFTER TOUCH** allows the performer control of **LFO** modulation effects while playing the

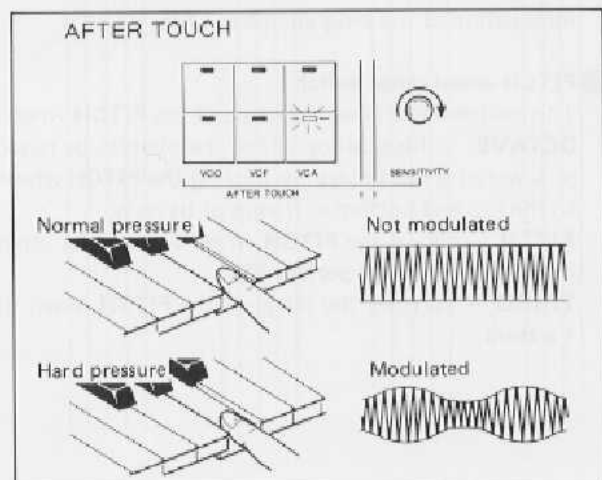

The real-time **LFO** and **PITCH/MODULATION** wheel blocks offer even further control of pitch and **LFO** modulation beyond that of the programmable controls, and allow modulation depth control in three different ways: **MODULATION** wheel, **FOOT CONTROLLER**, or **AFTER-TOUCH**.

## LFO

This block is full-function non-programmable **LOW FREQUENCY OSCILLATOR**. This **LFO** affects the sound of both channels, and can be used in conjunction with **LFO** modulation effects which have been programmed by the controls in the **PROGRAMMABLE LFO** block.

keyboard with both hands. After a note is struck, further pressure on the key will control the modulation depth (with the same effect as advancing the **MODULATION WHEEL**). This pressure can be applied to a varying degree, allowing very fine, fingertip control of the modulation depth.

## 62 DESTINATION (AFTERTOUCH)

These switches determine the routing of the **LFO** signal as applied by the **AFTERTOUCH**, and operate exactly like the **WHEEL/FOOT CONT DESTINATION** switches. Note that more than one destination may be selected for the **AFTERTOUCH** modulation effects.

## 63 SENSITIVITY

The **SENSITIVITY** control determines the range of modulation depth of the **AFTERTOUCH**. If this knob is turned clockwise, deeper **LFO** modulation will occur when aftertouch pressure is applied to the keys. Note the setting of the **MODULATION WHEEL** does not affect the **AFTERTOUCH** modulation.

## 64 MODULATION SWITCH

This switch selects the channels to which the non-programmable **LFO** is routed — **CHANNEL I**, **CHANNEL II**, or both (I + II). Interesting effects can be created using different kinds of modulation on separate channels by using this routing switch in conjunction with the programmable **LFO**.

## 65 MODULATION wheel

The **MODULATION** wheel controls the depth of **LFO** modulation to the blocks selected by the **DESTINATION** switches 61 and the **MODULATION** switch 64. Note that if the **WHEEL** switch 41 is on, the wheel will also control the depth of modulation of the programmable **LFO**.

## 66 PITCH wheel range switch

This switch determines the range of the **PITCH** wheel. **OCTAVE** — this position allows the pitch to be raised or lowered a full octave by moving the **PITCH** wheel to the top and bottom extremes of its range.

**FIFTH** — allows the **PITCH** wheel to vary the pitch of the oscillators + a perfect fifth.

**THIRD** — narrows the range of the **PITCH** down to + a third.

## 67 PITCH wheel

Allows real-time control over the pitch of the **VCO's**. Advancing this wheel towards the "+" will raise the pitch, towards the "-" will lower it, with the maximum range of this change determined by the **PITCH** bend switch 66.

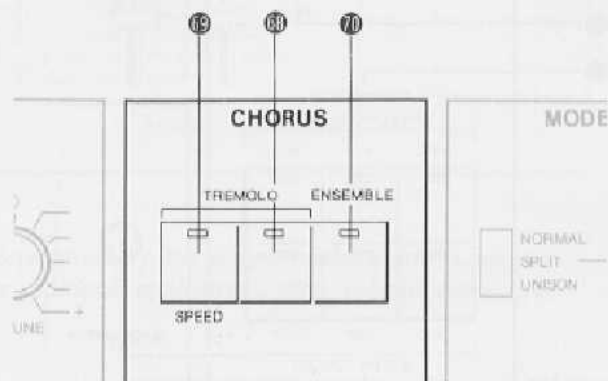

## ■ CHORUS Block

The CS70M features a built-in analog chorus device, allowing both chorus or ensemble as well as Leslie-speaker type effects. These effects are applied automatically to both channels I and II.

## 68 TREMOLO

The **TREMOLO** gives the sound of a variable speed, Leslie-type speaker. Once the **TREMOLO** is turned on, pressing the switch a second time, or turning on the **ENSEMBLE** switch, will turn off the **TREMOLO** effect.

## 69 TREMOLO SPEED

This switch controls the apparent speed of the **TREMOLO** effect, just as the speed of Leslie speaker's rotation can be controlled. When this switch is pressed, the **LED** indicator will light and the speed of the **TREMOLO** effect will increase from slow to fast **gradually**. If the switch is pressed again (turning the indicator off), the speed will gradually decrease back to the "slow" rate.

## 70 ENSEMBLE switch

This switch gives a analog chorus type effect, and is especially useful for string voicings. This effect is turned on by pressing the **ENSEMBLE** switch, causing the indicator to light. If the switch is pressed again, or if the **TREMOLO** is turned on, it will be turned off.

# Sound Patch Chart

**YAMAHA**  
**ESZOM**  
DUAL CHANNEL POLYPHONIC SYNTHESIZER

PROGRAMMABLE PARTS LISTING

**OUTPUT**



**UFX**



**MIX**



**OSCILLATOR RESOURCES**



**MTCN**



**OSCILLATOR**



**ORBITRN**



**REVERB**



**PROG M/USBL PARTS LISTING**



**AMP**



**ADSR**



**ENVL GEN**



DATE: / /

# Summary of Operations

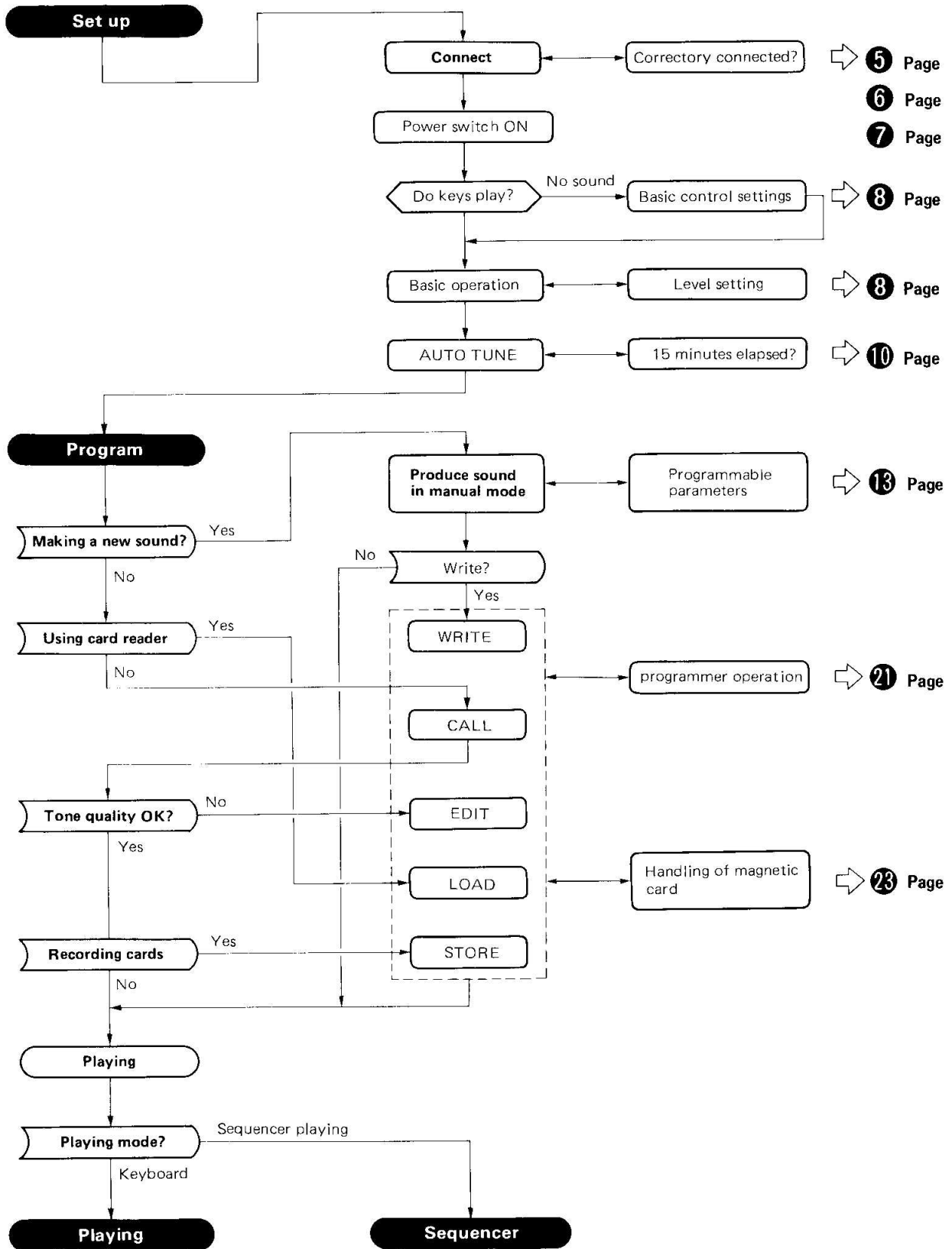

# Summary of Operations

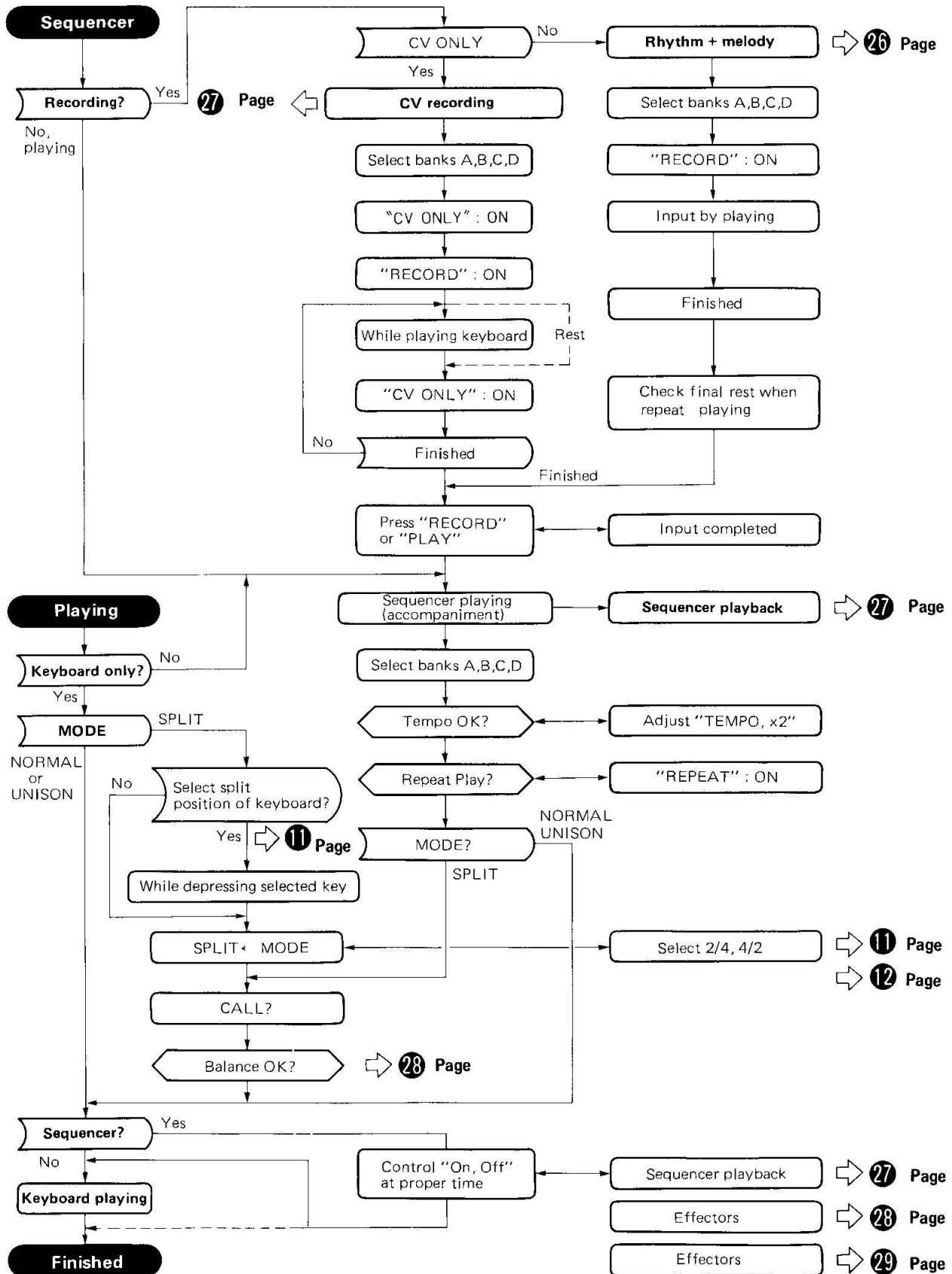

# Trouble Shooting

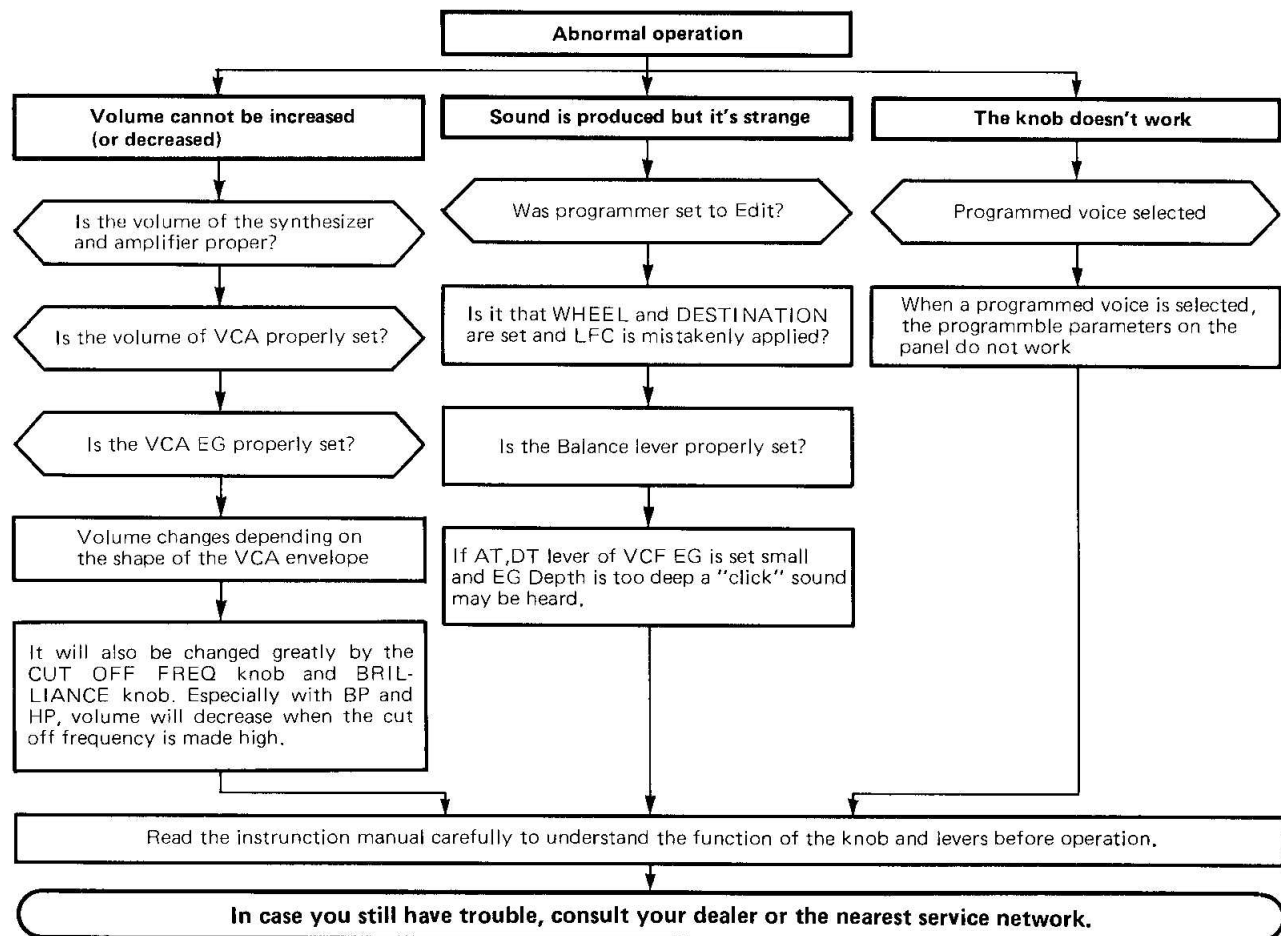
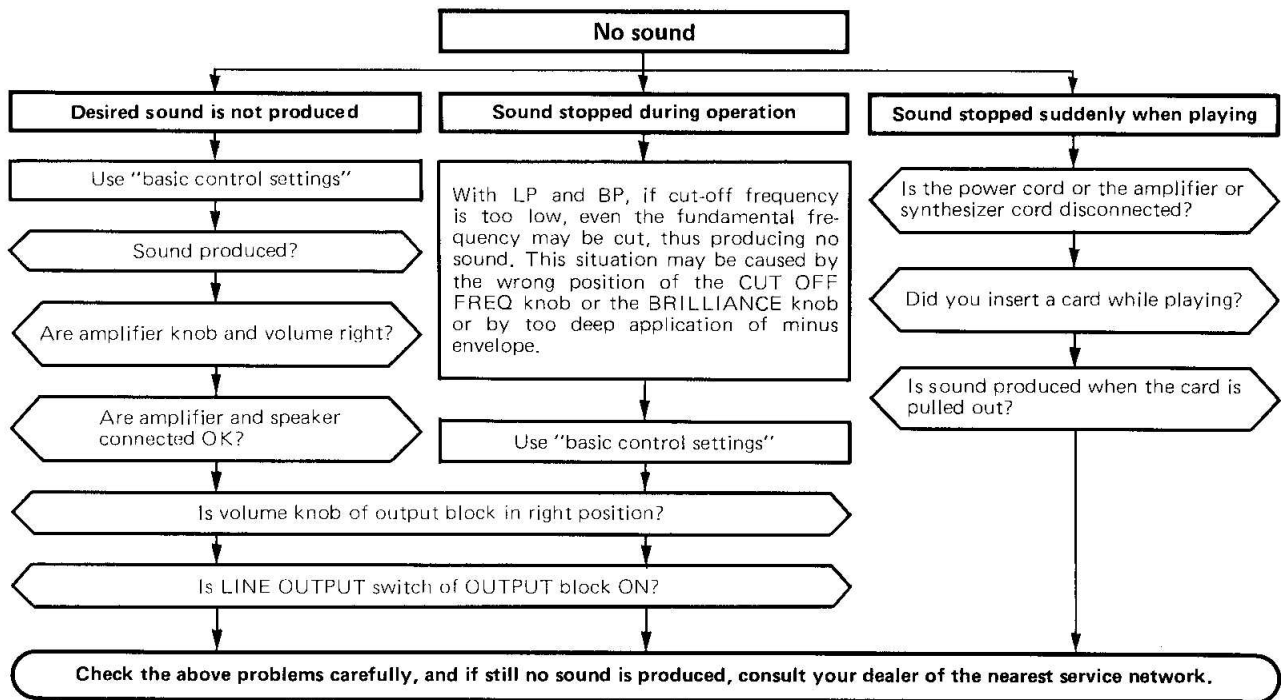



# Trouble Shooting

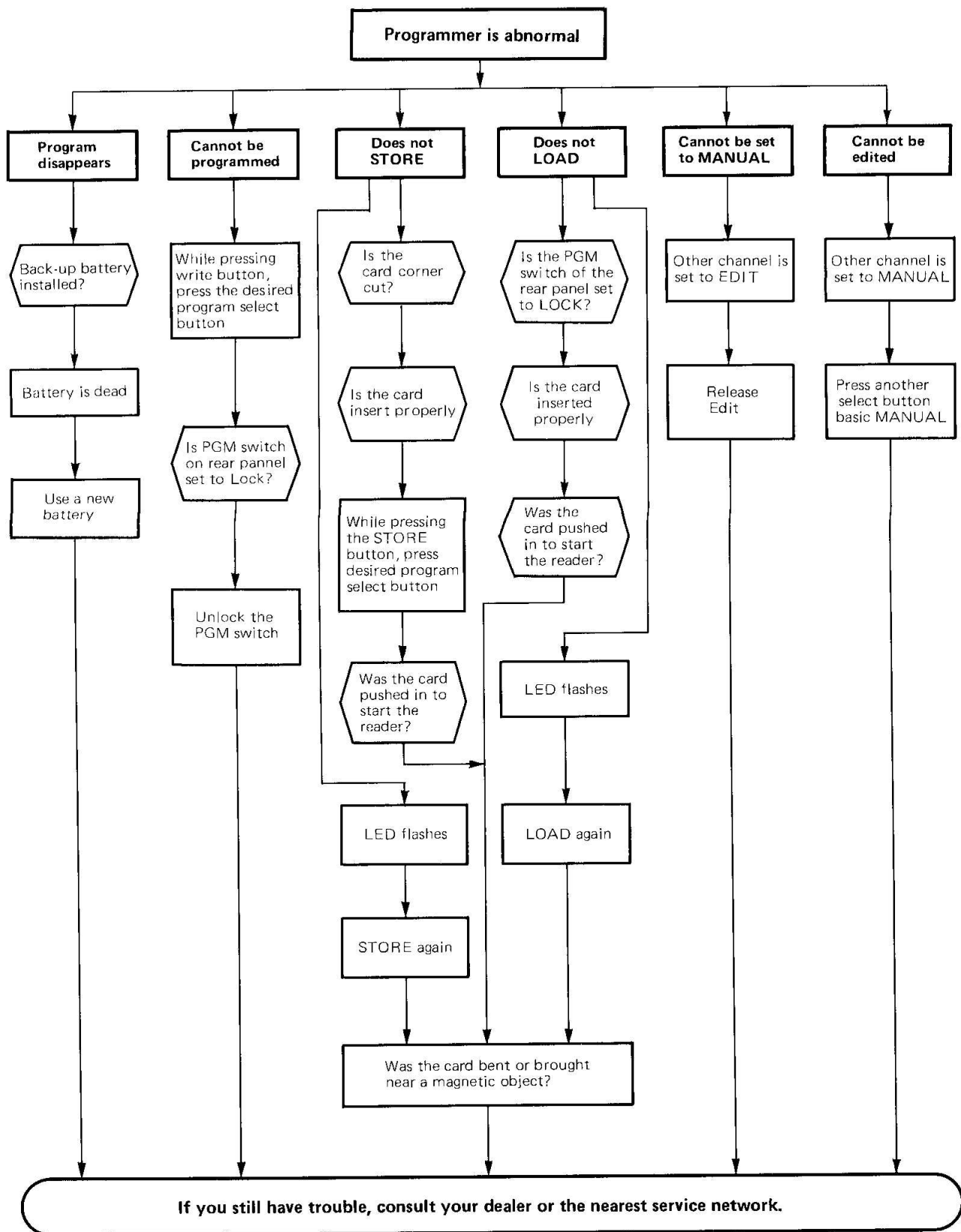

# Block Diagram

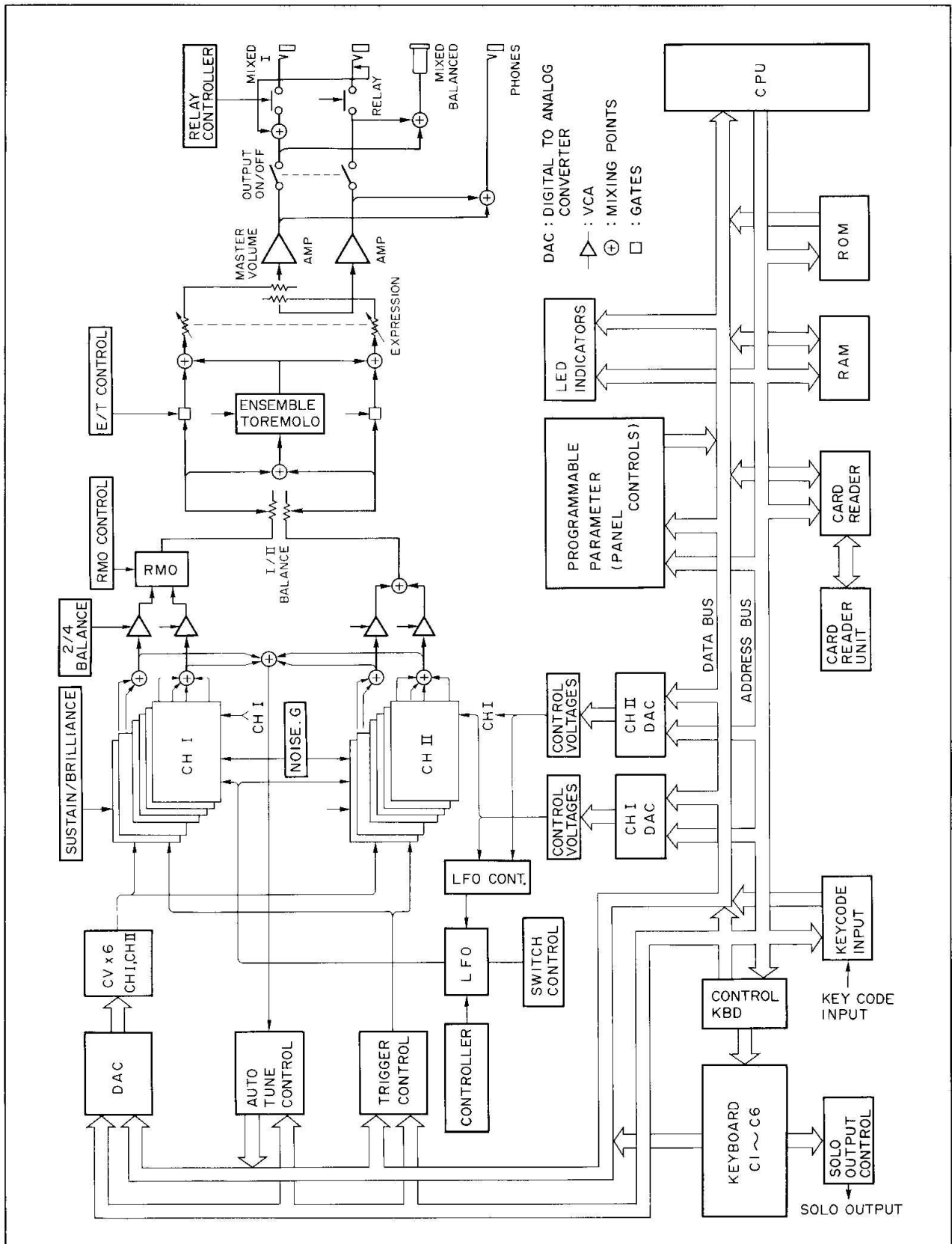

# Specifications

Keyboard . . . . . 61 keys, 5 octaves, C1 — C6

## OUTPUT Block

OUTPUT switch . . . ON/OFF (affect to MIXED/1, 2 and  
BALANCED output)  
VOLUME . . . . . Master volume control

## PITCH Block

TUNE . . . . . Variable range : -100 — +100 cents  
DETUNE . . . . . Channel II only, same as TUNE

## CHORUS Block

ENSEMBLE . . . . . Ensemble ON/OFF switch  
TREMOLLO . . . . . Tremolo ON/OFF switch  
SPEED . . . . . Tremolo speed control ;  
ON ; 6.4 Hz, OFF ; 0.64 Hz

## MODE Block

NORMAL/SPLIT/ . . . Mode switch  
UNISON . . . . . NORMAL 6 notes later priority basis  
SPLIT 2+4 or 4+2 notes split by  
later priority, split position  
can be changed within all  
range of keyboard  
UNISON 6 multiple sound by single  
note play  
2/4, 4/2 . . . . . Split note assignation

## LFO Block

~ / \ / / . . . . . LFO waveforms select  
SPEED . . . . . Variable range : 0.05 — 50 Hz  
DESTINATION . . . . . Switching destination  
WHEEL/FOOT CONT . . . VCO, VCF and VCA  
AFTER TOUCH . . . . . VCO, VCF and VCA  
SENSITIVITY . . . . . Sensitivity control of touch effect

## POLY-PHONIC SEQUENCER Block

TEMPO . . . . . Center : playback as same speed as  
record  
Variable range : 0.6 — 1 — 2 times  
X 2 . . . . . Twice in speed  
REPEAT . . . . . Repeat play enable  
CV ONLY . . . . . Record only notes, playback tempo  
determined by the TEMPO and X2  
A, B, C and D . . . . . Memory bank select, 608 total notes  
capable in single play  
RECORD . . . . . Record start/stop switch  
PLAY . . . . . Playback start switch

## PROGRAMMABLE PARAMETERS Block

VCO  
FEET-1, 2 . . . . . 2', 2'-2/3, 4', 5'-1/3, 8' and 16'  
~ / \ / / . . . . . Waveforms select  
PW . . . . . Pulse width control, 50 — 90%  
NOISE . . . . . White noise  
VCF  
HP, BP . . . . . Filter select switch,  
LP is selected if both swith are off  
LP and HP : -12dB/oct.  
BP : -6dB/oct.  
TIME x 5 . . . . . Time extension switch  
~ / \ / / . . . . . Envelope polarity switch  
CUT OFF FREQ . . . . . Cutoff frequency : 10 oct.  
RESONANCE . . . . . Resonance Q : 0.5 — 10  
EG DEPTH . . . . . 0 — 10 (10 oct. max.)  
ATTACK TIME . . . . . 1 msec — 1 sec  
DECAY TIME . . . . . 10 msec — 10 sec  
SUSTAIN LEVEL . . . . . 0 — 10  
RELEASE TIME . . . . . 10 msec — 10 sec  
VCA  
TIME x 5 . . . . . Envelope time extension  
HOLD . . . . . Any up to 6 notes can be hold  
ATTACK TIME . . . . . 1 msec — 1 sec  
DECAY TIME . . . . . 10 msec — 10 sec  
SUSTAIN LEVEL . . . . . 0 — 10  
RELEASE TIME . . . . . 10 msec — 10 sec  
VOLUME . . . . . 0 — 10

## LFO

SPEED . . . . . 0.1 — 100 Hz  
FINE . . . . . Speed fine adjustment  
EG DEPTH . . . . . LFO speed modulation control  
ATTACK TIME . . . . . 5 msec — 5 sec  
DECAY TIME . . . . . 50 msec — 50 sec  
MODULATION DEPTH . . . . . 0 — 10  
~ , \ , / , S/H, GLIDE+, GLIDE-, RMO  
LFO waveforms and RMO select  
DESTINATION . . . . . VCO, VCF, PW, VCA/I + II  
WHEEL . . . . . Wheel control enable switch

## EFFECTS Block

PORTAMENT/GLISSANDO . . . Portamento/Glissando  
select switch  
TIME . . . . . Speed control  
SUSTAIN . . . . . 10 msec — 10 sec  
BRILLIANCE . . . . . -3oct. — +3oct.  
BALANCE  
2 — 4 . . . . . Split mode volume balance  
I — II . . . . . Channel volume balance

## PROGRAMMER Block

1 — 15 . . . . . Program select switch  
MANUAL . . . . . Manual control  
Edit : able to edit by pressing  
program select switch twice  
(indicator flushing status)  
Write: write program data into RAM  
AUTO TUNE . . . . . Automatic tuning system is provided  
CARD Interface  
STORE . . . . . Write program data onto magnetic  
card from CS70M  
LOAD . . . . . Read program data into CS70M  
from magnetic card

## PITCH BEND WHEEL

OCT/FIFTH/THIRD . . . . . Switching variable range  
WHEEL . . . . . Pitch modulation control wheel

## REAR PANEL

OUTPUT . . . . . MIXED/1, 2  
BALANCED (Mixed)  
FOOT CONT. . . . . Foot controller terminal  
VOLUME : 40dB or more  
BRILLIANCE  
MODULATION  
FOOT SW . . . . . Foot switch terminal  
SUSTAIN : ON/OFF  
PORTAMENT : ON/OFF  
SEQUENCER PLAY : Start/Stop  
SOLO OUTPUT . . . . . Output solo-synthesizer equivalent  
signal  
CONTROL VOLT : V/Hz  
TRIGGER : Negative trigger  
Off ; +5V/On ; -5V  
KEY CODE INPUT . . . . . External keyboard (SK30 or SK50D)  
performance input  
PGM . . . . . Memory protection switch  
LOCK : Disable to write  
UNLOCK : Enable to write

POWER CONSUMPTION . . . . . 110 wattes  
DIMENSION . . . . . 1,120 x 180 x 500 mm  
44 x 7 x 19-3/4 in (W x H x D)  
WEIGHT . . . . . 28.8 kg, 63.4 lbs  
FINISH . . . . . Rose wood grained

Recommended amplifier . . . . . Keyboard amplifier or equivalent  
Optional equipment . . . . . Magnetic card set with holder BLC-40  
Foot switch FC-4  
Foot controller FC-3A

\* Specifications subject to change without notice  
due to improvement.

SINCE 1887  **YAMAHA**  
NIPPON GAKKI CO., LTD. HAMAMATSU, JAPAN